

data

SHEET

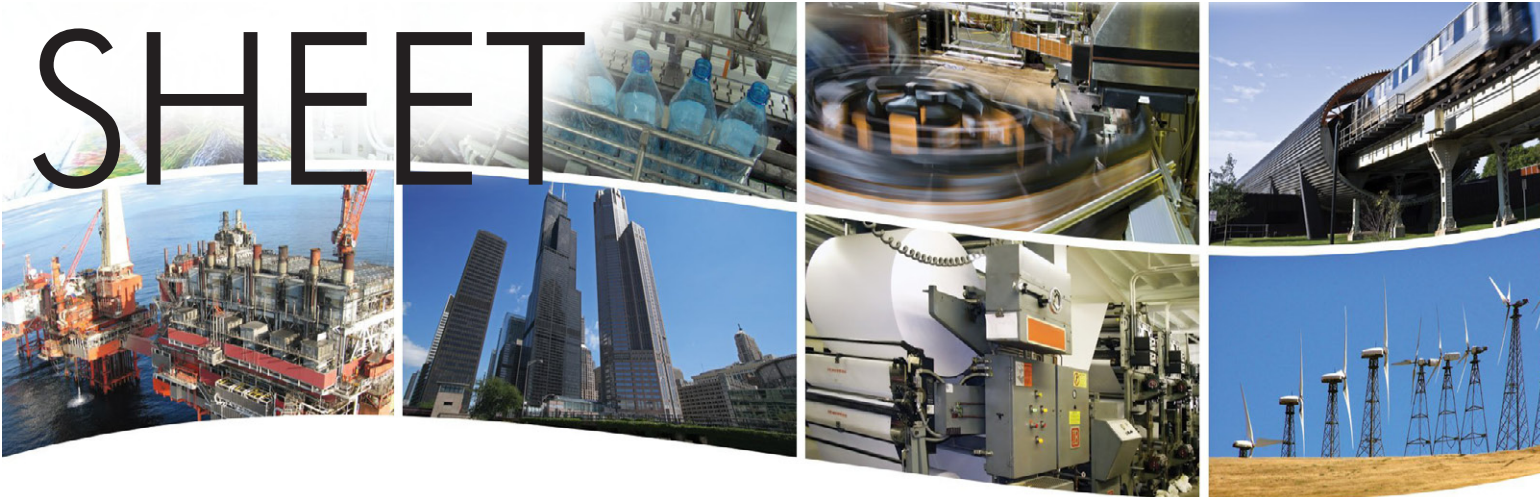

Automation Switch Series — comprehensive set of features plus high port density

The EIDX_M Series of Ethernet switches provide management functionality in situations where extended temperatures of -40°C to $+75^{\circ}\text{C}$ are expected. With a fixed width of 62 mm, these units offer 16 or 24 ports with copper and fibre/copper combinations.

In addition to the conventional features standard in Plug-and-Play switches, the EIDX_M Series offers many important managed-switch benefits. These benefits includes IGMP snooping and IGMP query, RapidRing[®], VLAN, Quality of Service (QoS), port

mirroring, rate limiting, trunking, port security, the Simple Network Management Protocol (SNMP), and the Rapid Spanning Tree Protocol (RSTP).

Configure the unit by web browser via any Ethernet port — or in terminal mode via the local console port. Using either of these methods, port parameters, feature configuration and device status can be monitored and/or modified. A configurable relay is present for attaching fault-monitoring equipment.

Features

- 16 or 24 10/100 Mbps ports
- Extended temperature range: -40°C to $+75^{\circ}\text{C}$
- LEDs for link/activity, data rate, power, status
- Console or web page configuration
- CE Mark compliant, RoHS compliant

Management Functionality

- Managed via the SNMP protocol
- IGMP snooping & query functionality
- Cable redundancy using STP, RSTP or RapidRing
- Virtual LAN support (Port VLAN and 802.1Q)
- Quality of Service (QoS) support
(802.1p, DiffServ, TOS, Port-based, MAC-based)
- Port mirroring, rate limiting and port security



EIDX16M-100T/FC

EIDX24M-100T/FC

CTRLink[®]

Product Overview

The Automation Switch is available in eight models — two all-copper and six copper/fibre. Fibre support includes multimode fibre with either ST or SC connectors or single mode fibre with SC connectors. Fibre port data rates are fixed at 100 Mbps full-duplex while all the copper ports can auto-negotiate data rate from 10 to 100 Mbps and from half- to full-duplex. Both the 16- and 24-port models have eight ports on the front and eight ports on the bottom while the 24-port model has an

additional eight ports on top. Copper ports utilize shielded RJ-45 connectors.

An abundance of LED indicators are available for monitoring switch status and port status.

The unit can be either DIN-rail or panel mounted and can be powered from a 24 VAC/VDC power source. A N.O. contact is available for signalling a fault condition to external equipment.

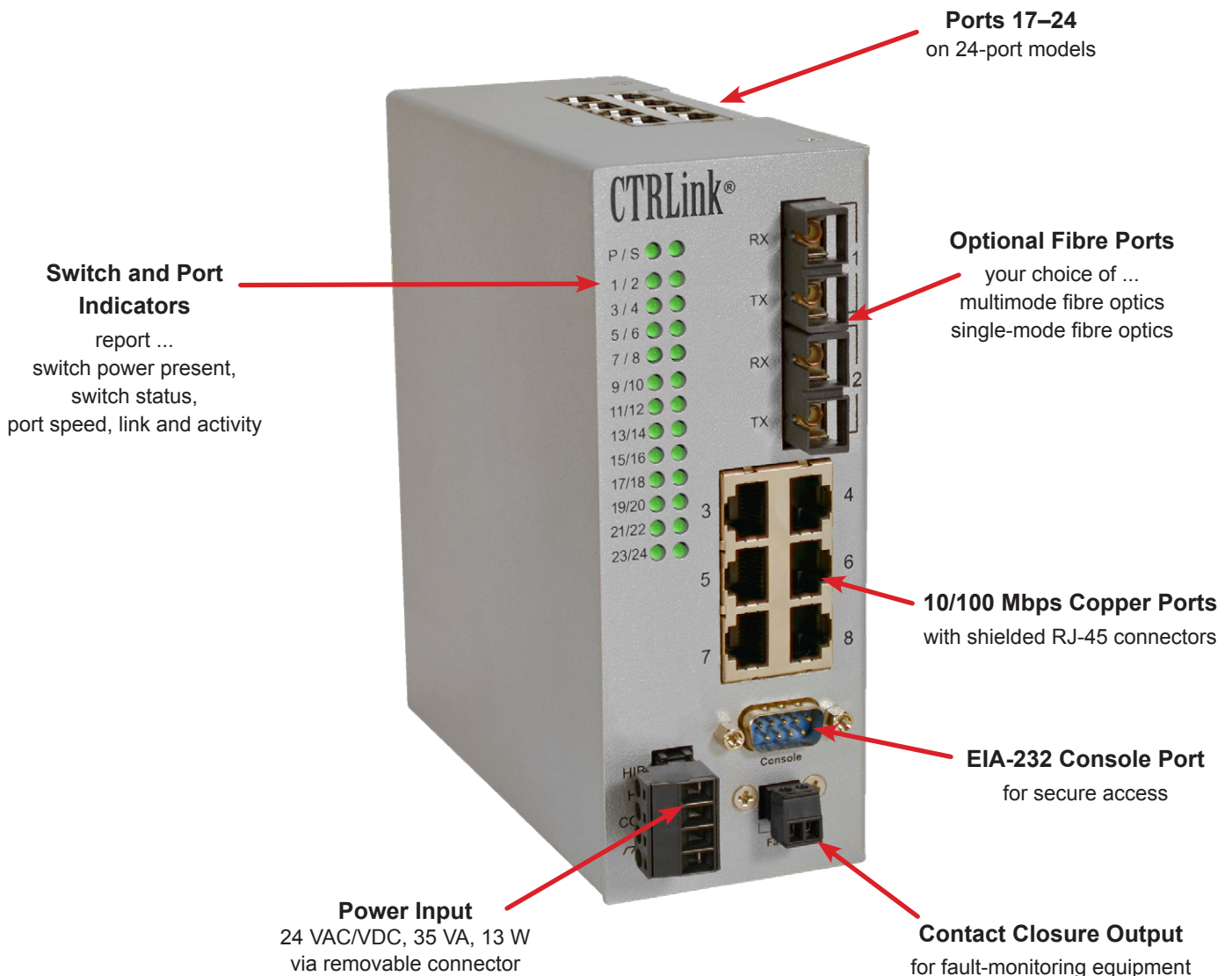

M-Software — gaining the most from a managed switch

A managed switch is defined as one that supports the Simple Network Management Protocol (SNMP). Sophisticated Ethernet controller technology with numerous features exists in Contemporary Controls' managed switch products. The company's resident M-Software brings out these features thereby allowing its customers the ability to take control of their network. Configuring the M-Software is via a web browser or console port or both.

Authentication

A username and password is required to access the configuration screens.

Port Configuration

By default, all copper ports will auto-negotiate speed, duplex and flow control. However, port settings can be preset to suit specific needs. SNMP Management Information Base (MIB) data can be displayed for each switch port in order to gain a complete understanding of the performance of each port.

IP Address Assignment

A default private IP Address, Subnet Mask and Default Gateway Address are factory installed but they can be changed by the user. Instead of a fixed IP address, a DHCP client in the unit will request dynamic settings from a DHCP server. A method exists for resetting the unit to factory default settings.

Trunking

In order to improve uplink throughput, ports can be aggregated in one of two groups so as to function as one higher performing port. Up to four copper ports can be assigned to each trunk group. Cable redundancy with extremely fast recovery times is inherent in trunk groups.

Port Mirroring

Ethernet switches improve throughput by restricting directed traffic only to those ports party to the intended traffic. Although performance is improved, network troubleshooting is more difficult because a packet sniffer attached to another port may not be able to monitor all traffic. The solution is to create a mirror port to the ports party to the traffic being monitored. A mirror port can monitor any of the other ports with filtering based on source or destination addresses or even a particular MAC address.

Virtual Local Area Network (VLAN)

VLANs allow the same Ethernet infrastructure to accommodate concurrent but separate networks dedicated to different functions — such as accounting and building automation. Each VLAN supports IEEE 802.1Q tagging where each VLAN is assigned a unique VLAN tag (VID). For each VID, ports on the switch become members of the group or they are marked as non-members. Switch ports can be instructed to append a VLAN tag to an ingress (inbound) Ethernet frame or drop VLAN tags on egress (outbound) frames providing the greatest flexibility in establishing VLANs. Overlapping VLANs can be created if strict isolation is not wanted.

Port Forwarding and Filtering Database

Ethernet switches learn the port upon which an Ethernet station can be reached and this information is entered into its filtering database. Subsequent traffic to Ethernet stations recorded in the database is then restricted to these known ports. While this activity is automatically accomplished as a background task, the filtering database can be modified to meet specific needs. The Aging of the filtering database entries is configurable. Static entries based upon MAC addresses can be entered into the database. The same applies to multicast addresses. Four levels of priority can be set based upon MAC addresses.

M-Software — continued

Quality of Service (QoS)

By enabling Quality of Service, Ethernet frames can be given varying degrees of priorities when messages are being queued. There are several QoS methods which can be enabled. QoS can be established on strictly a port basis where some ports are given priority over others. IEEE 802.1p priority levels can be honoured or ignored on a port basis. Although there are eight 802.1p priority levels, these levels are mapped to four levels used by the switch. Support also exists for Type of Service (TOS) and Differentiated Services (DiffServ). Although both TOS and DiffServ priorities have been pre-mapped into four levels, these assignments can be modified.

Programmable Fault Relay

A voltage-free contact closure is available for external alarming based upon individual port status. The relay can be programmed to either make or break on a fault condition. Fault conditions could be set for either No Link or Link Present. Fault sensing can be enabled on any of the ports providing the greatest flexibility.

Cable Redundancy

Three forms of cable redundancy are possible – Spanning Tree Protocol (STP), Rapid Spanning Tree Protocol (RSTP) and Contemporary Controls' proprietary RapidRing®. For mesh networks, either STP or RSTP (recommended) is available and their parameters can be configured accordingly. For ring topologies, RapidRing is the best option yielding the fastest recovery time — typically less than 300 ms with 100 switches.

Rate Limiting

Data throughput can be throttled on a port basis for both ingress and egress ports in order to reduce the number of dropped frames on highly loaded networks. Traffic restrictions can be applied individually to Broadcast, Multicast or Unicast messages or to all types of messages.

Port Security

Increased security settings can be enabled on a port basis. Specific MAC addresses can be assigned to particular ingress or egress ports.

Internet Group Management Protocol (IGMP) Snooping

Both IGMP snooping and IGMP querier are supported in order to reduce multicast traffic to devices which have no interest in this traffic. An IGMP forwarding map can be created on a port basis. The Multicast Filtering Database Aging time is configurable as is the Query Interval time.

Simple Network Management Protocol (SNMP)

As a managed switch, the switch supports SNMP and can be configured for System Name, Location and Contact. Private and Public Community String access can be configured for read-only or read/write access. Up to four IP Trap Receivers can be identified. MIB data is available for each port.

Performance Monitor

A performance monitor exists to assist in troubleshooting. The filtering database can be browsed for entries. When enabling the Spanning Tree Protocol, the forwarding or discarding states of each port can be monitored. Finally, a trap log exists for any SNMP traps that have occurred.

Specifications

Input Power Requirements	24 VAC \pm 5% 35 VA 24 VDC \pm 10% 13 W	
Operating Temperature	-40°C to 75°C	
Storage Temperature	-40°C to 85°C	
Relative Humidity	10–95%, non-condensing	
Protection	IP30	
Shipping Weight	2 lb (0.90 kg)	
Ethernet Communications	IEEE 802.3 10/100 Mbps data rate 10BASE-T, 100BASE-TX physical layer, 100 m (max) CAT5 cable length 100BASE-FX physical layer, 2,000 m (max) multimode cable (-FT, -FC models) 100BASE-FX physical layer, 15,000 m (max) single mode cable (-FCS models)	
Console Communications	EIA-232 DTE (9600, 1, 1)	
LED indicators	P	Power Green = Power OK
	S	Status Green = Processor status OK Red = Processor status fault
	1–24	Port Green = 100 Mbps link present; flashes with activity Yellow = 10 Mbps link present; flashes with activity

Regulatory Compliance CE Mark; CFR 47, Part 15 Class A; RoHS; UL508



RJ-45 Connector Pin Assignments

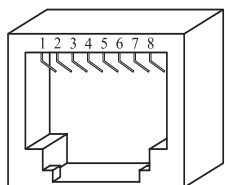

Ethernet

Pin	Function
1	+TD
2	-TD
3	+RD
4	N/C
5	N/C
6	-RD
7	N/C
8	N/C

DB-9 Console Pin Assignments

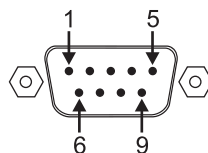

EIA-232

Pin	Function
1	N/C
2	RD
3	TD
4	N/C
5	Signal Ground
6	N/C
7	N/C
8	N/C
9	N/C

Power Diagrams

The EIDX_M requires a voltage of either 24 VDC $\pm 10\%$ or 24 VAC $\pm 5\%$ via a four-pin removable keyed connector and draws current commensurate with power consumption. Power conductors should be sized accordingly and can be stranded (16–18 AWG) or solid (16–22 AWG). Consult the Specifications section for power requirements.

Redundant diode-isolated DC power inputs are provided so the EIDX_M can operate despite the loss of primary power. Both sources must provide required power. The power options appear below. COM and the equipment chassis are isolated from each other. Input connections are reverse-polarity protected.

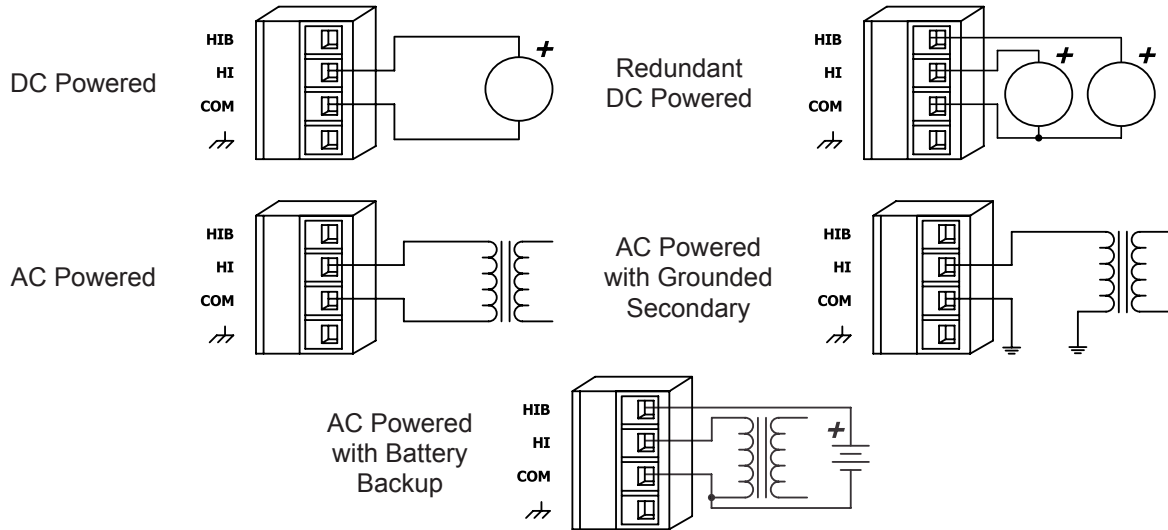

Mechanical Drawing

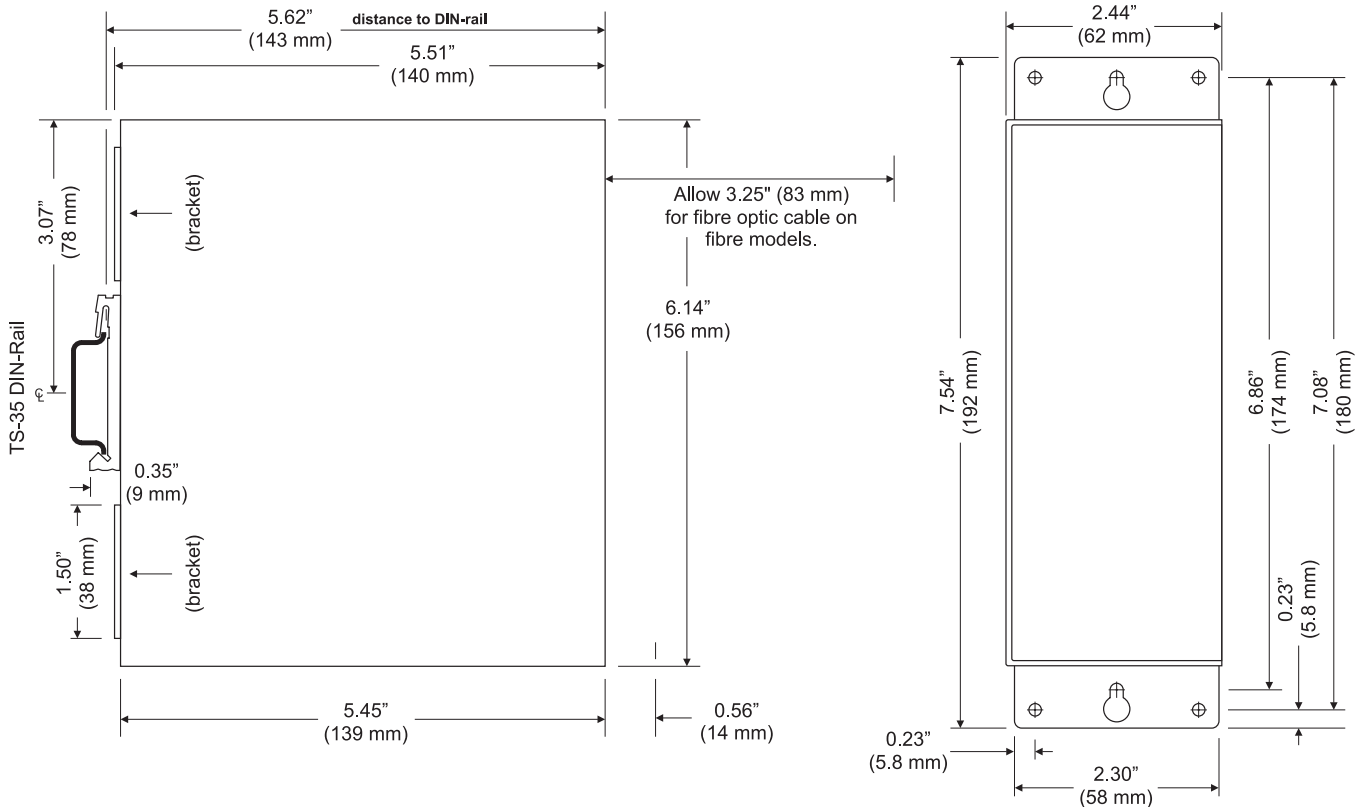

Side View showing DIN-rail Clip (Mounting Brackets Retracted)

Front View with Mounting Brackets Extended

Cable Redundancy

With managed switch products, three methods of protecting a network from a single cable fault are offered — STP, RSTP and RapidRing®. Both STP and RSTP allow for ring or mesh topology, Contemporary Controls' proprietary Rapidring® is only intended for ring topology. With RapidRing® one switch is designated a master while all other switches are relegated as slaves with one ring input port and one ring output port. All segments are active except the segment between the last slave in the ring and the master's backup port. If a break is detected along the ring, the master invokes the backup segment to re-establish communications. Once the fault is restored, the backup segment is disabled.

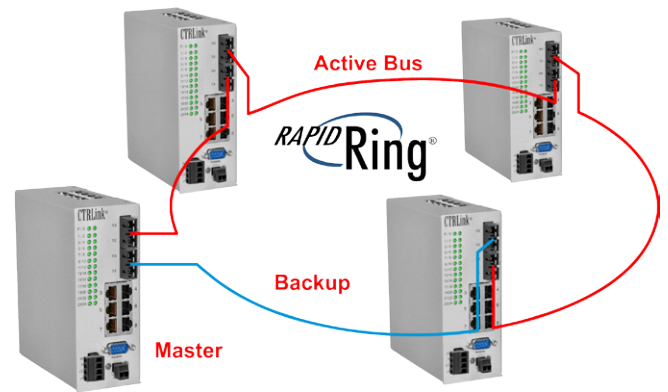

Trunking

Another cable redundancy scheme is called trunking where multiple parallel paths pass between adjacent switches. If one of the paths is broken, the alternative path or paths maintain communications. Trunking has the added advantage that throughput increases with each added parallel path.

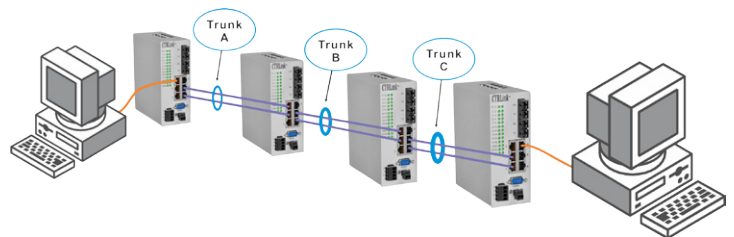

Virtual Local Area Networks (VLANs)

VLANs allow for the segregation of traffic within one geographically large physical network making devices that belong to a particular VLAN appear as if they reside in a unique physical network. All devices residing in the one physical network are assigned to individual VLANs and it is possible for one device to be a member of multiple VLANs. One advantage of VLANs is that all VLAN traffic — unicast, multicast and broadcast — is restricted to its VLAN without the other VLANs being impacted.

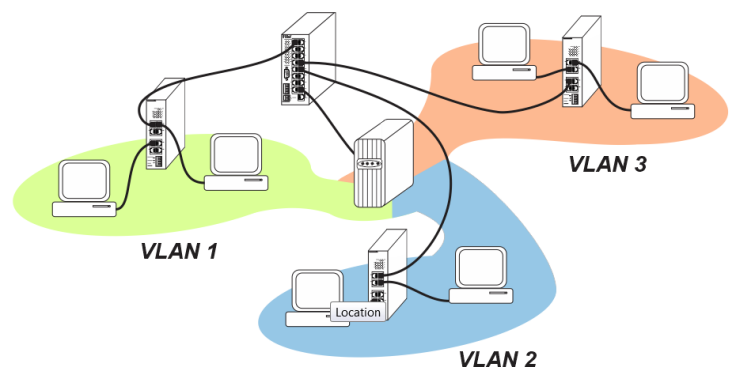

Ordering Information

Model	RoHS	Description
EIDX16M-100T	✓	16-Port 10/100Mbps Managed EIDX Switch
EIDX24M-100T	✓	24-Port 10/100Mbps Managed EIDX Switch
EIDX16M-100T/FC	✓	14-Port 10/100Mbps 2-Port MM SC-fiber Managed EIDX Switch
EIDX16M-100T/FCS	✓	14-Port 10/100Mbps 2-Port SM SC-fiber Managed EIDX Switch
EIDX16M-100T/FT	✓	14-Port 10/100Mbps 2-Port MM ST-fiber Managed EIDX Switch
EIDX24M-100T/FC	✓	22-Port 10/100Mbps 2-Port MM SC-fiber Managed EIDX Switch
EIDX24M-100T/FCS	✓	22-Port 10/100Mbps 2-Port SM SC-fiber Managed EIDX Switch
EIDX24M-100T/FT	✓	22-Port 10/100Mbps 2-Port MM ST-fiber Managed EIDX Switch

United States

Contemporary Control Systems, Inc.
2431 Curtiss Street
Downers Grove, IL 60515
USA

Tel: +1 630 963 7070
Fax: +1 630 963 0109

info@ccontrols.com
www.ccontrols.com

China

Contemporary Controls (Suzhou) Co. Ltd
11 Huoju Road
Science & Technology
Industrial Park
New District, Suzhou
PR China 215009

Tel: +86 512 68095866
Fax: +86 512 68093760

info@ccontrols.com.cn
www.ccontrols.asia

United Kingdom

Contemporary Controls Ltd
14 Bow Court
Fletchworth Gate
Coventry CV5 6SP
United Kingdom

Tel: +44 (0)24 7641 3786
Fax: +44 (0)24 7641 3923

info@ccontrols.co.uk
www.ccontrols.eu

Germany

Contemporary Controls GmbH
Fuggerstraße 1 B
04158 Leipzig
Germany

Tel: +49 341 520359 0
Fax: +49 341 520359 16

info@ccontrols.de
www.ccontrols.eu