

BASGE-EN902

EnOcean to BACnet Gateway 902 MHz (North American Version)

EnOcean to BACnet Gateway



User Manual

UM-BASGE902-AA0

Firmware Version 2.x

CONTEMPORARY CONTROLS®

Trademarks

BASautomation, Contemporary Controls and CTRLink are registered trademarks of Contemporary Control Systems, Inc. BACnet is a registered trademark of the American Society of Heating, Refrigerating and Air-Conditioning Engineers, Inc. Powered by Sedona Framework is a trademark of Tridium, Inc. Other product names may be trademarks or registered trademarks of their respective companies.

Copyright

© Copyright 2024, by Contemporary Control Systems, Inc. All rights reserved. No part of this publication may be reproduced, transmitted, transcribed, stored in a retrieval system, or translated into any language or computer language, in any form or by any means, electronic, mechanical, magnetic, optical, chemical, manual, or otherwise, without the prior written permission of:

Contemporary Control Systems, Inc. 2431 Curtiss Street Downers Grove, IL 60515, USA	Tel: +1-630-963-7070 Fax: +1-630-963-0109 E-mail: info@ccontrols.com
Contemporary Controls Ltd (UK)	Tel: +44 (0)24 7641 3786 Fax: +44 (0)24 7641 3923 E-mail: ccl.info@ccontrols.com
Contemporary Controls (Suzhou) Co. Ltd	Tel: +86 512 68095866 Fax: +86 512 68093760 E-mail: info@ccontrols.com.cn
Contemporary Controls GmbH (Germany)	Tel: +49 (0)341 520359 0 Fax: +49 (0)341 520359 16 E-mail: ccg.info@ccontrols.com

Disclaimer

Contemporary Control Systems, Inc. reserves the right to make changes in the specifications of the product described within this manual at any time without notice and without obligation of Contemporary Control Systems, Inc. to notify any person of such revision or change.

Contents

1	Safety Information: FCC statement	5
	FCCID: 2AU57BASGE-EN902.....	5
	IC RSS-Gen Antenna Statement.....	6
	Déclaration d'antenne CN RSS-Gen	6
	IC RF Exposure Statement.....	6
	Déclaration d'exposition aux radiations.....	7
2	Introduction.....	8
2.1	Features and Benefits	9
	Versatile Gateway and Control Device.....	9
	Convenient Installation.....	9
2.2	Product Image and Main Features.....	9
3	Specifications	10
3.1	Power (Class 2 Circuits Only).....	10
3.2	Communications	10
3.3	Environmental.....	10
3.4	Ethernet LED Indicators	10
3.5	Electromagnetic Compatibility (EN902)	11
3.6	Ordering Information	11
3.7	Mechanical Drawing (all dimensions are in inches).....	12
4	Installation.....	13
4.1	Power Connection	13
4.2	Power Supply Precautions	13
4.3	Wiring Diagram.....	13
4.4	Web Page Configuration	13
	Reset IP.....	14
5	Virtual BACnet Routing to Discover EnOcean Devices.....	15
5.1	Supported EEPs.....	15
5.2	Virtual BACnet Devices.....	15
6	EnOcean to BACnet Gateway Webpage Configuration.....	17
6.1	Home	17

6.2	Configure.....	17
6.2.1	Configure Settings	17
6.2.2	Configure Password.....	18
6.3	Add Devices.....	19
6.4	Remote Commissioning	22
6.4.1	Virtual Output Device Registration Page	25
6.5	Mapping Status.....	29
6.6	Upload/Download	29
7	Using the Gateway to Control LEDRU	30
8	BACnet Protocol Implementation Conformance Statement (PICS)	31
9	Warranty	32
10	Returning Products for Repair	32
11	Declaration of Conformity	32

1 Safety Information: FCC statement

FCCID: 2AU57BASGE-EN902

This equipment has been tested and found to comply with the limits for a Class A digital device, pursuant to Part 15 of the FCC Rules. These limits are designed to provide reasonable protection against harmful interference in a residential installation. This equipment generates, uses and can radiate radio frequency energy and, if not installed and used in accordance with the instructions, may cause harmful interference to radio communications.

However, there is no guarantee that interference will not occur in a particular installation.

If this equipment does cause harmful interference to radio or television reception, which can be determined by turning the equipment off and on, the user is encouraged to try to correct the interference by one or more of the following measures:

- Reorient or relocate the receiving antenna.
- Increase the separation between the equipment and receiver.
- Connect the equipment into an outlet on a circuit different from that to which the receiver is connected.
- Consult the dealer or an experienced radio/TV technician for help.

This equipment complies with FCC radiation exposure limits set forth for an uncontrolled environment.

This equipment must be installed and operated in accordance with provided instructions and the antenna(s) used for this transmitter must be installed to provide a separation distance of at least 20 cm (7.87 in) from all persons and must not be co-located or operating in conjunction with any other antenna or transmitter.

NOTE: Any changes or modifications not expressly approved by the grantee of this device could void the user's authority to operate the equipment.

This device complies with Industry Canada license-exempt RSS standard(s). Operation is subject to the following two conditions:

- (1) This device may not cause interference.
- (2) This device must accept any interference, including interference that may cause undesired operation of the device.

Le présent appareil est conforme aux CNR d'Industrie Canada applicables aux appareils radio exempts de licence. L'exploitation est autorisée aux deux conditions suivantes:

- (1) L'appareil ne doit pas produire de brouillage
- (2) L'utilisateur de l'appareil doit accepter tout brouillage radioélectrique subi, même si le brouillage est susceptible d'en compromettre le fonctionnement.

- i. The device for operation in the band 902 MHz is only for indoor use to reduce the potential for harmful interference to co-channel mobile satellite systems.
 - ii. The maximum antenna gain permitted for devices in the band 902 MHz shall be such that the equipment still complies with the e.i.r.p. limits specified for point-to-point and non-point-to-point operation as appropriate.
 - iii. Users should also be advised that high-power radars are allocated as primary users (i.e., priority users) of the bands 902 MHz and that these radars could cause interference and/or damage to LE-LAN devices.
-
- i. Les dispositifs fonctionnant dans la bande de 902 MHz sont réservés uniquement pour une utilisation à l'intérieur afin de réduire les risques de brouillage préjudiciable aux systèmes de satellites mobiles utilisant les mêmes canaux;
 - ii. Pour les dispositifs munis d'antennes amovibles, le gain maximal d'antenne permis (pour les dispositifs utilisant la bande de 902 MHz) doit être conforme à la limite de la p.i.r.e. spécifiée pour l'exploitation point à point et l'exploitation non point à point, selon le cas;
 - iii. Les utilisateurs devraient aussi être avisés, d'une part, que les utilisateurs de radars de haute puissance sont désignés utilisateurs principaux (c.-à-d., qu'ils ont la priorité) des bandes de 902 MHz, d'autre part, que ces radars pourraient causer du brouillage et/ou des dommages aux dispositifs de RL-EL.

IC RSS-Gen Antenna Statement

This radio transmitter (IC: 31004-BASGEEN902) has been approved by Industry Canada to operate with the antenna types listed below with the maximum permissible gain indicated. Antenna types not included in this list, having a gain greater than the maximum gain indicated for that type, are strictly prohibited for use with this device.

Déclaration d'antenne CN RSS-Gen

Le présent émetteur radio (IC: 31004-BASGEEN902) a été approuvé par Industrie Canada pour fonctionner avec les types d'antenne énumérés ci-dessous et ayant un gain admissible maximal. Les types d'antenne non inclus dans cette liste, et dont le gain est supérieur au gain maximal indiqué, sont strictement interdits pour l'exploitation de l'émetteur.

IC RF Exposure Statement

Radiation Exposure: This equipment complies with IC radiation exposure limits set forth for an uncontrolled environment. This equipment should be installed and operated with a minimum distance of 20 cm (7.87 in) between the radiator and your body.

Déclaration d'exposition aux radiations:

Cet équipement est conforme aux limites d'exposition aux rayonnements IC établies pour un environnement non contrôlé. Cet équipement doit être installé et utilisé avec un minimum de 20 cm de distance entre la source de rayonnement et votre corps.

Approved antenna for EnOcean gateway: BASGE-ANT902 (from Contemporary Controls)

Antenna specifications: 50 ohm, gain 2 dBi, efficiency 70% at 902 MHz

Approved antenna for EnOcean gateway: BASGE-ANT902-1M (from Contemporary Controls)

Antenna specifications: 50 ohm, gain 0.7 dBi, efficiency 55% at 902 MHz

Antenne approuvée pour la passerelle EnOcean : BASGE-ANT902 (de Contemporary Controls)

Spécifications de l'antenne : 50 ohms, gain 2 dBi, efficacité 70 % à 902 MHz

Antenne approuvée pour la passerelle EnOcean : BASGE-ANT902-1M (de Contemporary Controls)

Spécifications de l'antenne : 50 ohms, gain 0.7 dBi, efficacité 55 % à 902 MHz

2 Introduction

The EnOcean to BACnet Gateway provides the systems integrator with a flexible building block when integrating EnOcean wireless devices to BACnet/IP networks or expanding the number of EnOcean points in an existing building automation system. Thanks to virtual routing technology, the EnOcean to BACnet gateway seamlessly discovers and connects to EnOcean devices and makes them appear as individual BACnet-compliant devices. The gateway creates a set of BACnet objects, specific for each EnOcean Equipment Profile (EEP), and decodes the received EnOcean data into standard BACnet objects, such as analog-inputs for temperatures, humidity, light levels, etc. and multistate objects for EnOcean values that represent multiple states, for easy integration to BACnet system - saving the head-end from decoding the transmitted EnOcean data.

The EnOcean to BACnet Gateway can be DIN-rail or panel mounted requiring one 10/100 Mbps Ethernet connection, and 24 VAC/VDC power. Its half-wave rectified power supply allows sharing of power with other half-wave devices. The gateway can also remotely configure EnOcean devices which support EnOcean remote configuration.

The 1.x EnOcean to BACnet gateway allowed the discovery of EnOcean devices (sensors, switches, etc.) and have their transmitted data mapped to BACnet devices and objects. Each EnOcean device appears as a separate BACnet device using the EnOcean to BACnet gateway.

The EnOcean devices can also be manually entered into the gateway. The gateway provides the status of each EnOcean device and can display the last transmitted value from the EnOcean device.

The 2.x EnOcean to BACnet gateway provides all the features of the 1.x version along with additional features. In the 2.x firmware the gateway provides bi-directional EnOcean ability. The gateway can be used to create virtual output EnOcean devices. These devices reside in the gateway. Each virtual device will create a BACnet device which can be written via BACnet. Once written, the gateway will transmit EnOcean messages, acting as the virtual EnOcean device. The virtual device can be bound to real EnOcean output devices, or it can be placed in the Link Table of remote commissionable devices, such as the EnOcean Inc. LEDRU.

The 2.x gateway also provides the ability to discover EnOcean devices which support remote commissioning. Once they are discovered their Link Table can be modified. Also, the virtual output EnOcean devices can be added to their Link Table. This allows the gateway to control remote commissionable devices from BACnet writes targeted to the gateway's virtual output devices.

2.1 Features and Benefits

Versatile Gateway and Control Device

- Bidirectional gateway functionality between EnOcean Wireless and BACnet/IP
- EnOcean device discovery with built-in EEPROM
- Remote commissioning of link tables and configuration settings
- Each EnOcean device appears as virtual BACnet device to aid in integration
- Received EnOcean data is decoded into standard BACnet objects
- Built-in EnOcean Device Profiles for seamless integration
- Webpage configuration—no external tools or software required

Convenient Installation

- 10/100 Mbps Ethernet with auto-negotiation and Auto-MDIX
- 24 VAC/VDC powered
- DIN-rail or panel mounting
- EnOcean SMA connector provides flexible antenna options

2.2 Product Image and Main Features

The SMA connector supports a stick antenna (as shown in the product image below) or an antenna with 2 m cable for mounting the antenna outside the control cabinet.

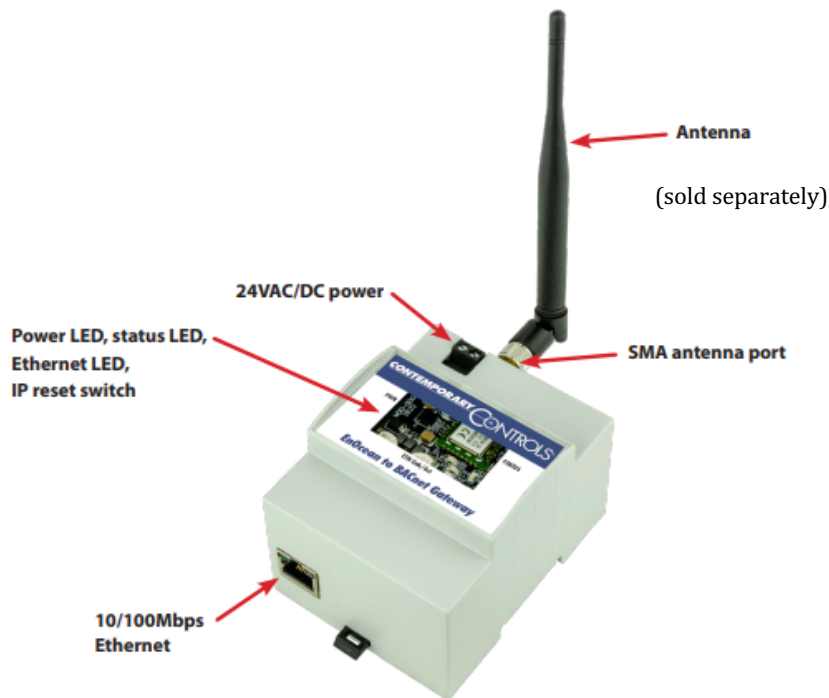

3 Specifications



3.1 Power (Class 2 Circuits Only)

Item	Limits
Input Power	24 VAC/DC \pm 10%, 6VA 47-63 Hz, 3W

3.2 Communications

Protocol	Description
BACnet/IP	IEEE 802.3 10/100 Mbps data rate 10BASE-T, 100BASE-TX, 100 m (max) CAT5 cable length
EnOcean	902MHz (EN902 model), 30 m typical distance inside buildings

3.3 Environmental

Item	Description
Operating Temperature	0°C to 60°C
Storage Temperature	-40°C to +85°C
Relative Humidity	10-95%, non-condensing
Regulatory Compliance	FCC CFR 47, Part 15 Subpart C 2AU57BASGE-EN902; IC RSS-210 31004-BASGEEN902   

3.4 Ethernet LED Indicators

LED Indicator	Indication
Link (L)	Green: 100 Mbps, flashes with activity
Tx/Rx	Green: Activity

3.5 Electromagnetic Compatibility (EN902)

Test Method
EN 55032:2015+A1:2020
EN 55032:2015+A11:2020
EN 55035:2017+A11:2020
ESTI EN 301 489-1 V2.2.3 (2019-11)
ESTI EN 301 489-3 V2.3.2 (2023-01)
FCC CFR Title 47 Part 15 Subpart B: 2022 ANSI C63.4:2014
FCC CFR Title 47 Part 15 Subpart C Section 15.231 ANSI C63.10:2013 RSS-210 Issue 10 RSS-Gen Issue 5

3.6 Ordering Information

Model	Description
BASGE-EN902	EnOcean to BACnet Gateway 902 MHz
BASGE-ANT902 (sold separately)	EN902 stick antenna: 50 ohm, gain 0.86 dBi, efficiency value 25% at 902 MHz
BASGE-ANT902-2M (sold separately)	EN902 antenna with a 2 m cable: 50 ohm, gain 0.68 dBi, efficiency value 55% at 902 MHz

3.7 Mechanical Drawing (all dimensions are in inches)

Wiring: 16 to 18 AWG wires or 1.5mm² wires

Mounts directly onto panel or DIN rail.

Width: 3.56 in

Height: 2.44 in

Depth: 2.81 in

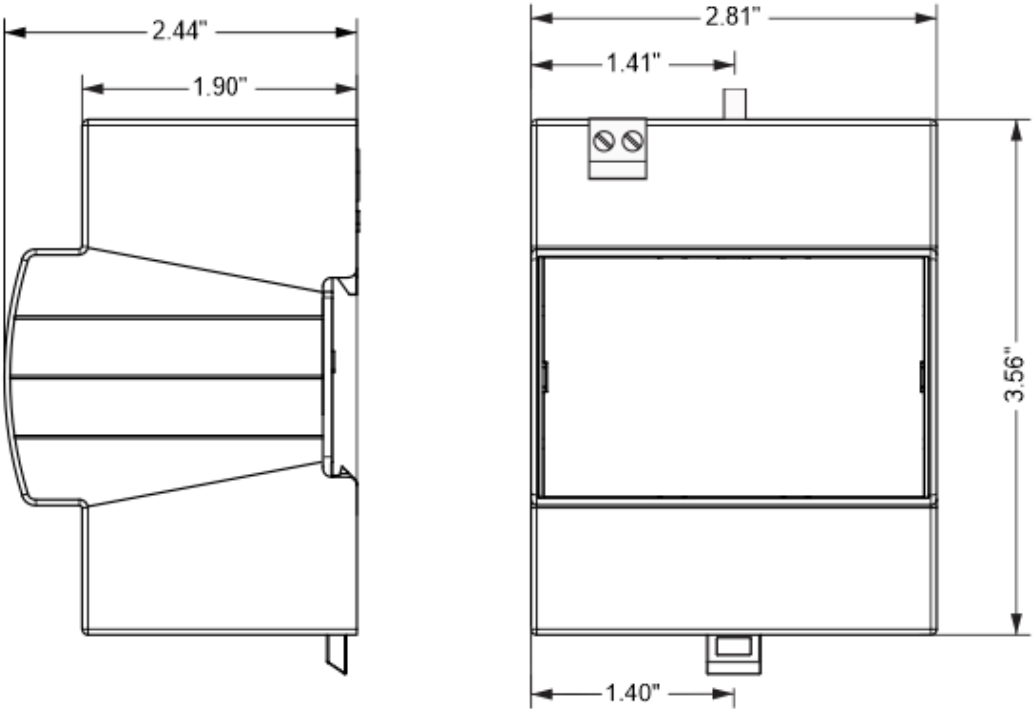

4 Installation

4.1 Power Connection

The EnOcean to BACnet Gateway requires 24 VAC or 24 VDC while drawing no more than 6 VA of power. The recommended conductor size is 16–18 AWG. COM is directly connected to zero volts and the chassis is DC isolated from zero volts. Input connections are reverse-polarity protected. See figure below for power options.

4.2 Power Supply Precautions

Internally, this device utilizes a half-wave rectifier and therefore can only share the same AC power source with other half-wave rectified devices. Sharing a common DC power source is also possible. Sharing AC power with full-wave rectified devices is NOT recommended. Devices powered from a common AC source could be damaged if a mix of half-wave and full-wave rectified devices exists.

4.3 Wiring Diagram

4.4 Web Page Configuration

The EnOcean to BACnet Gateway contains an interactive web server accessible from any Internet-compatible PC on the local network with recent versions of most standard web browsers such as Microsoft Internet Explorer, Microsoft Edge, Mozilla Firefox, or Google Chrome installed.

To configure the gateway initially, connect it to your Windows PC using an Ethernet cable and set the PC's IP and subnet mask in Local Area Connection → Properties. In the Internet Protocol Version 4 (TCP/IPv4) settings of your Windows PC, specify an IP address and a Subnet mask in the same subnet as the gateway (e.g., 192.168.92.5 /24).

- EnOcean to BACnet Gateway's factory-programmed default IP address: 192.168.92.68 with a Class C subnet mask of 255.255.255.0 (/24).
- User Name and Password: admin/admin

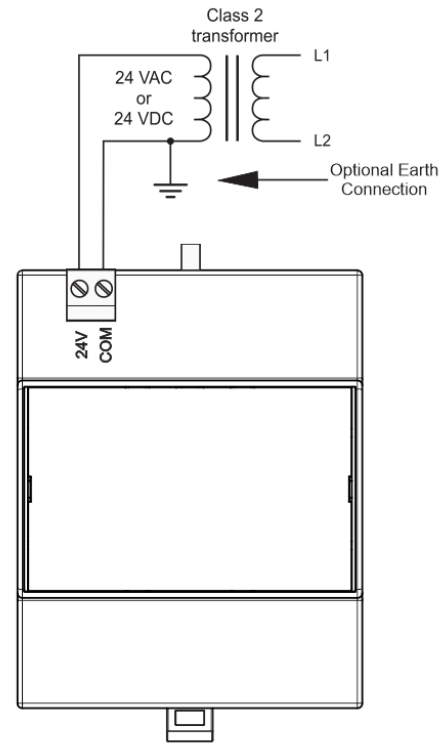

Reset IP

Remove the top cover, locate the reset IP switch (see picture) and while the unit is powered press for 10 seconds. The unit will reboot, and you can access it via the IP address and user name/password defaults shown above. Please wait 30 seconds for the gateway to complete its booting process

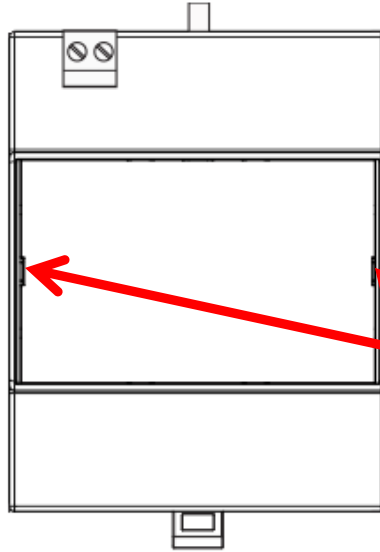

Use a flat head screwdriver at either of these two locations to take off the top cover.

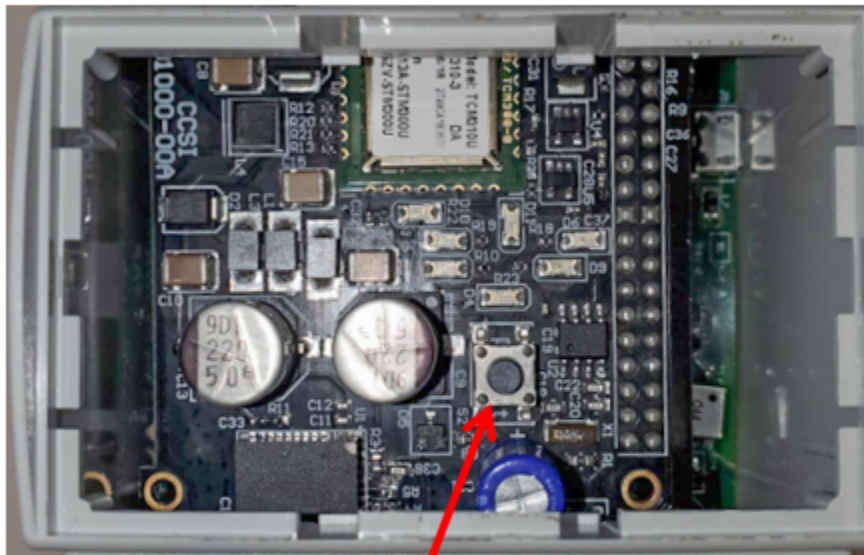

Reset IP

5 Virtual BACnet Routing to Discover EnOcean Devices

You can discover EnOcean devices or manually enter them into the gateway via the EnOcean to BACnet gateway webpages. You will select the appropriate EEP for each EnOcean device.

5.1 Supported EEPs

The EEP defines how the data is structured in the EnOcean message. The EnOcean to BACnet Gateway supports input and output EEPs. An input EEP is for a device that transmits EnOcean messages, and the gateway brings that data to BACnet.

EnOcean to BACnet Gateway Supported Input EEPs							
a50205	a50701	a51004	a5100d	a51018	a51101	d2030a	f60101
a50213	a50702	a51005	a51010	a51019	a51200	d20310	f60201
a50214	a50703	a51006	a51011	a5101a	a51405	d21430	f60202
a50401	a50801	a51007	a51012	a5101b	a52001	d21441	f60203
a50402	a50802	a51008	a51013	a5101c	a53001	d21500	f60204
a50403	a50904	a51009	a51014	a5101d	a53002	d23200	f60401
a50601	a51001	a5100a	a51015	a5101f	a53003	d23202	f60501
a50602	a51002	a5100b	a51016	a51022	a53808	d24000	f60502
a50603	a51003	a5100c	a51017	a51023	a53f7f	d50001	f61000
							f61001

5.2 Virtual BACnet Devices

Once entered into the gateway, a virtual input BACnet device will be created and can be discovered from a BACnet client or head-end. This virtual BACnet device will have appropriate BACnet objects to expose the data provided by the EnOcean device, such as Analog-Input objects for temperatures, humidity, light levels, etc. and multistate objects for conditions reported by the EnOcean device and binary objects for simple on/off EnOcean status. Each device will also have an RSSI object which provides the signal strength for the last received EnOcean message from the associated EnOcean device. It will also have a Minutes after Last Reception object which will indicate when the gateway last received a message from the EnOcean device. A value of "-1" indicates it never received a message since it last powered up. These are only for EnOcean input devices such as sensors, rocker switches, etc. Virtual output devices will not have these objects. The gateway will refresh the values in these objects when new EnOcean messages are received. A COV subscription can also be used to keep the BACnet client up to date with the changing data in these objects.

With the BACnet protocol, physical BACnet devices are assigned unique device instances. In this way, any BACnet device within the same BACnet internetwork can be uniquely identified. Accommodations

must be made for non-BACnet compliant devices such as EnOcean devices but the ability to uniquely identify each EnOcean device within the BACnet internetwork can be retained thanks to the EnOcean to BACnet gateway and the concept of virtual networking. Collectively, all the selected EnOcean devices are assigned to a virtual BACnet network number during configuration. Using the concept of virtual BACnet routing, each uniquely addressed EnOcean device appears as an individual BACnet device with a unique BACnet device instance assignment. Within this BACnet device are a collection of BACnet objects that relate to the data the EnOcean devices transmit.

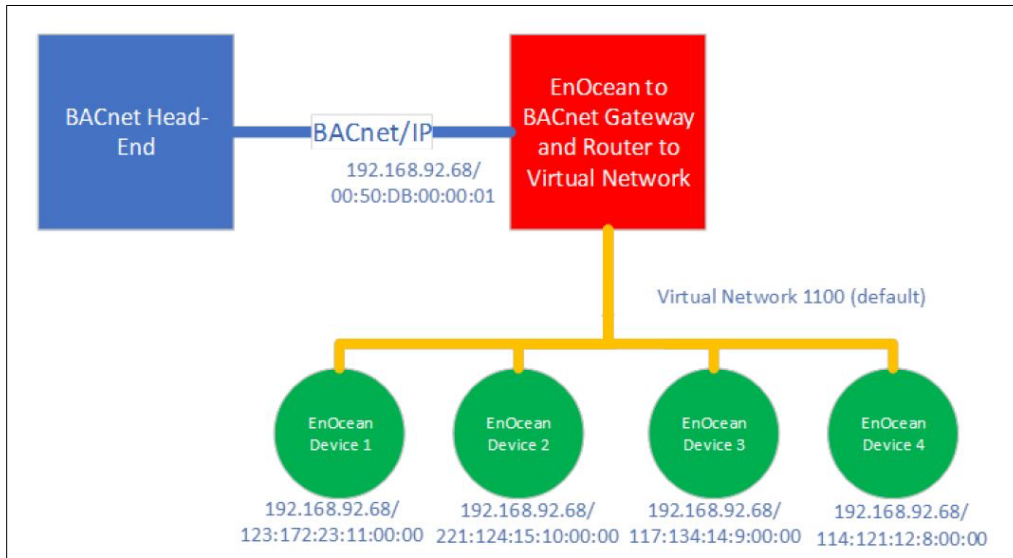

The BACnet head-end sees the EnOcean devices as standard BACnet devices through the EnOcean to BACnet Gateway, which acts as a BACnet router to the virtual network containing the EnOcean devices. Each EnOcean device has the IP address of the gateway and appears to be on network 1100 with an automatic BACnet MAC address.

6 EnOcean to BACnet Gateway Webpage Configuration

6.1 Home

The gateway can be fully configured from the Home page.

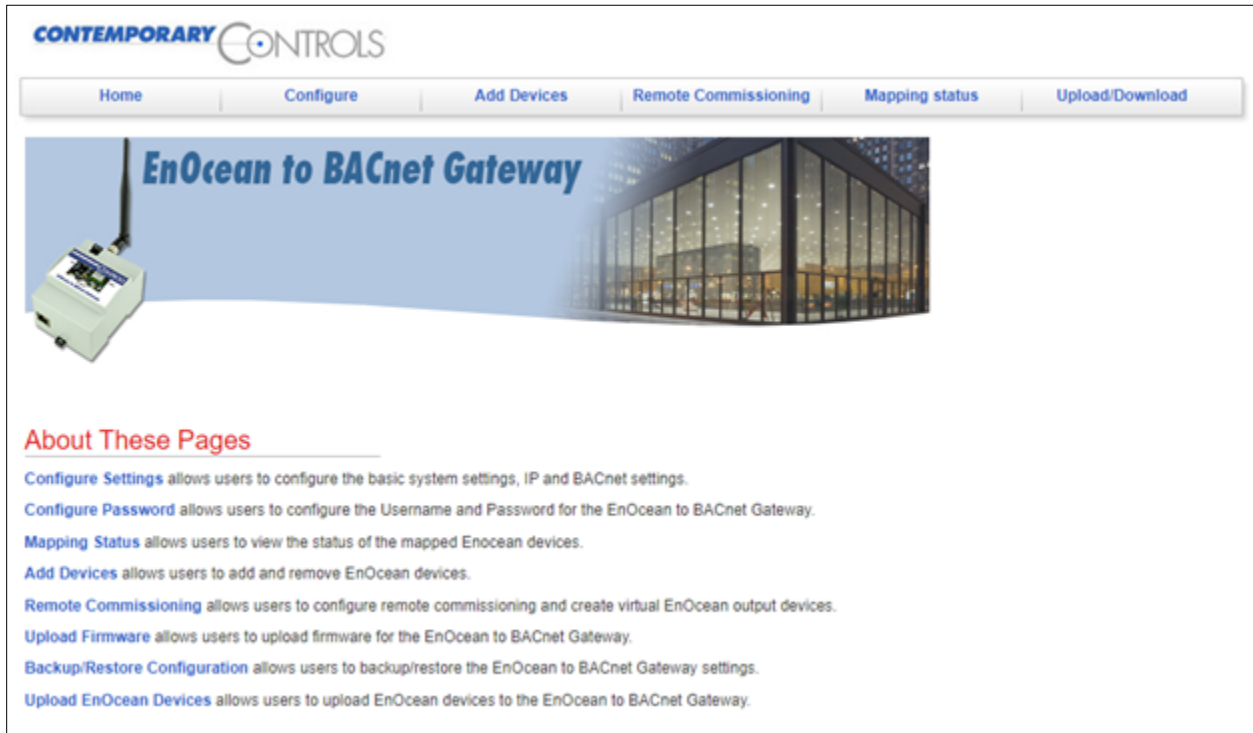

6.2 Configure

6.2.1 Configure Settings

From the Configure web page, select **Configure Settings** to change the BACnet & IP settings of the gateway. The gateway will route BACnet data to virtual BACnet devices it creates on the network corresponding to EnOcean devices created or added on the gateway webpage. The virtual network number is unique as this is the network which the gateway will route to for its created BACnet devices. The "Gateway Address" is the address of the IP router which is used to reach other subnets or the Internet. If the EnOcean to BACnet gateway's traffic is not being routed through IP routers, then leave this at 0.0.0.0. The BACnet device instance is the BACnet device object instance used by the gateway. UDP port is the BACnet UDP port used for BACnet communications to the gateway. BBMD IP address is the IP address of the BBMD which the gateway will register as a foreign device if this is required by your network. If not leave this value at 0.0.0.0. ReadPropertyMultiple support can be disabled or enabled. Disable this option if the gateway is communicating through MS/TP networks. COV interval controls how often a COV notification can be sent by the gateway.

Configure Settings

System

System Name:	<input type="text" value="BASenocean"/>
IP Address:	<input type="text" value="10.0.15.231"/>
Subnet Mask:	<input type="text" value="255.255.240.0"/> ▼
Gateway Address:	<input type="text" value="0.0.0.0"/>

BACnet

Device Instance:	<input type="text" value="15231"/>	(0 - 4194302)
UDP Port:	<input type="text" value="0xBAC0"/>	(Hexadecimal value e.g. 0xBAC0)
BBMD IP Address:	<input type="text" value="0.0.0.0"/>	
BBMD Reg Time:	<input type="text" value="100"/>	secs
Virtual Network:	<input type="text" value="15231"/>	(1 - 65534)
ReadPropertyMultiple:	<input type="text" value="ENABLED"/> ▼	
COV Poll Interval:	<input type="text" value="1000"/>	(1000 - 60,000 msec)

6.2.2 Configure Password

The **Configure Password** option allows the configuration of the user ID and password. If the IP address or user ID/password of the gateway is lost, press the IP reset button on gateway. This button is located under the cover of the gateway. Press it for 10 seconds and the gateway will reboot. The IP address will change to 192.168.92.68, and the user ID/password will be admin/admin. All other BACnet settings will also return to factory settings. Please wait 30 seconds for the reboot to complete. Then connect to the gateway and modify these settings.

6.3 Add Devices

The Add Devices webpage can be used to manually enter EnOcean devices or to discover EnOcean devices. To manually enter a device the EURID (manufacturer set unique EnOcean ID) and EEP (type of EnOcean device—usually provided by the manufacturer of the device) must be known. Enter a unique BACnet ID or device instance to be used in the gateway when it creates a BACnet device to carry the data from the EnOcean device. The name value is the unique BACnet device object name to be used in the same BACnet device.

When discovering EnOcean devices, click the **Start Discovery** button. Activate your EnOcean device by pressing its **Learn** button or perform other activities that cause the EnOcean device to transmit. When the device's EURID appears in the list of discovered devices, click **Stop Discovery** and fill out the provided form. Previously registered EnOcean devices will not appear in the list of discovered devices.

Device Discovery and Registration

Please click on the Start Discovery button to begin discovering nearby unregistered EnOcean devices, or register devices manually by clicking the manual registration button.

EURID

0413d834

0413d81d

0413d6c3

0412f243

Manually register EnOcean device by filling out the following form:

EURID:

EEP:

BACnet ID:

Name:

Select the devices to enter into the gateway by checking the box in the Select column. Select the appropriate EEP value from the drop down. This should be provided by the EnOcean device manufacturer. If the EEP for your device is not shown, contact Contemporary Controls, and we can provide you with additional EEPs for your device.

Select	EURID	EEP	Name	BACnet ID
<input type="checkbox"/>	0413d834	d2 03 0a ▼	Enter name for device	Enter unique BACnet ID for c
<input type="checkbox"/>	0413d81d	a5 02 05 ▼	Enter name for device	Enter unique BACnet ID for c
<input type="checkbox"/>	0413d6c3	d2 03 0a ▼	Enter name for device	Enter unique BACnet ID for c
<input type="checkbox"/>	0412f243	d2 03 0a ▼	Enter name for device	Enter unique BACnet ID for c

Register Cancel

Enter the selected BACnet device object name and BACnet device ID (BACnet device object instance). Then click the **Register** button. After registering your devices, they should appear in the list of registered devices.

You can select a device in the registered devices list to remove it from the list by clicking the provided delete button. The devices with a “Real” type are EnOcean sensors or EnOcean transmitting devices. The “Virtual” devices are virtual EnOcean output devices. Instructions on how to add, edit, and remove registered devices will be discussed in the next section, **Remote Commissioning**.

Entered devices will appear in BACnet after a reboot of the gateway. To reboot the gateway, go to the Upload/Download menu on the Home page and select **Backup/Restore**, then click the **Update** button.

Registered Devices

EURID	EEP	Name	BACnet ID	TYPE
00257530	f60202	Rocker+Switch	252314	Real
0413d69f	d21441	multisensor1	151232	Real
051c32f8	a50403	temperature_sensor	403151	Real
SELF	d50001	LED_RU	64523	Virtual
SELF	d50001	LED_Light1	65432	Virtual
SELF	d50001	LED_Light2	24315	Virtual
SELF	d50001	LED_Light3	525334	Virtual
SELF	d50001	LED_Light4	34412	Virtual
SELF	d50001	LED_Light5	420953	Virtual
SELF	d50001	LED_Light6	413631	Virtual
SELF	d50001	LED_Light7	420621	Virtual
SELF	d50001	Round_Light1	41360	Virtual
SELF	d50001	Round_Light10	413623	Virtual
SELF	d50001	Round_Light11	4205	Virtual
SELF	d50001	Round_Light12	4202	Virtual
SELF	d50001	Round_Light2	413707	Virtual
SELF	d50001	Round_Light3	41331	Virtual
SELF	d50001	Round_Light4	41351	Virtual
SELF	d50001	Round_Light5	41365	Virtual
SELF	d50001	Round_Light6	413163	Virtual
SELF	d50001	Round_Light7	413608	Virtual
SELF	d50001	Round_Light8	4137145	Virtual
SELF	d50001	Round_Light9	41363	Virtual

The following image shows three devices which were located using the BACnet Discovery Tool (BDT). The BASenocean device (Device 0015231) has no objects except for a device object. The multisensor1 (Device 0015232) has BACnet objects for the EnOcean data provided by this sensor. The BACnet data will contain the latest information transmitted by the EnOcean device.

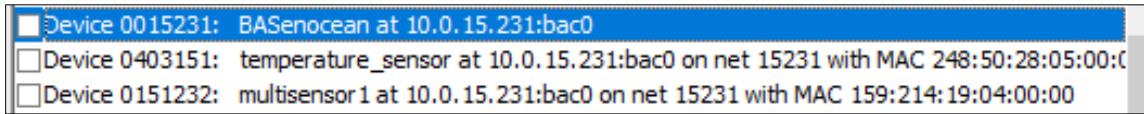

The image to the right shows the latest information transmitted by the EnOcean device (0151232), which includes temperature, humidity, illumination, sensor status, x, y, z acceleration data, magnetic contact status, RSSI and minutes after last EnOcean reception. RSSI is a signal strength indication. If the value is "0" then, no messages have been received from the EnOcean device. The less negative the value, the greater its strength. For example, "-40" is stronger than "-60." The "Minutes after last reception" is the number of minutes since the gateway received an EnOcean message from this device. If the value is "-1," then no messages have been received since the gateway has started.

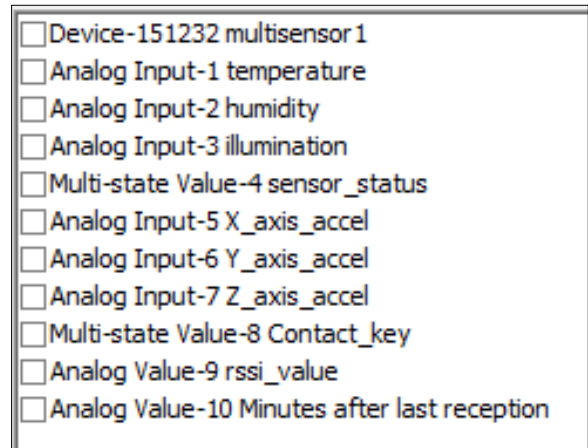

The multisensor has one multistate value object. BACnet multistate objects cannot have the value 0. The the EEP document on the EnOcean Alliance website shows sensor status ranges from 0 to 2 for D2-14-41 (see below). Because the multistate cannot have a 0 value, this object will range from 1-3 in the gateway, where 1 indicates the periodic update, 2 is the threshold that 1 exceeded, and 3 is the threshold 2 exceeded value. Some BACnet tools will give you the multistate string and not the value so you will not see this issue. However, if your BACnet tool provides the integer value of the multistate, then you will see this change from the EEP. The mapping status webpage will only show the integer value of the multistate. BDT below shows both the integer value and the multistate string.

35	2	Acceleration Status	Status of the sensor	Enum:	
				0 :	Periodic Update
				1 :	Threshold 1 exceeded
				2 :	Threshold 2 exceeded

Object Properties

Object Name: Write

Present Value:

In_Alarm Fault Overridden Out_of_Service Show Priorities

Refresh

Write Value:

Priority: Write

OK Cancel

6.4 Remote Commissioning

The Remote Commissioning webpage can be used to remotely commission or configure an EnOcean device, configure virtual EnOcean output devices, or have the gateway transmit a learn message on behalf of a virtual EnOcean output device.

To perform remote commissioning, enter in the unlock code for your EnOcean devices. The default value is used by default with devices from EnOcean, Inc. Click the **Start Discovery** button and the list of devices should appear. Only remote commissionable devices can be discovered.

Controller Discovery and Remote Commissioning

Please click on the Start Discovery button to begin discovering nearby EnOcean Controllers

Registered Devices

EURID	EEP	Name	BACnet ID	TYPE	ACTION
00257530	f60202	Rocker+Switch	252314	Real	
0413d69f	d21441	multisensor1	151232	Real	
051c32f8	a50403	temperature_sensor	403151	Real	
SELF	d50001	LEDRU	64523	Virtual	<input type="button" value="Learn"/>
SELF	d50001	LED_Light1	65432	Virtual	<input type="button" value="Learn"/>
SELF	d50001	LED_Light2	24315	Virtual	<input type="button" value="Learn"/>
SELF	d50001	LED_Light3	525334	Virtual	<input type="button" value="Learn"/>
SELF	d50001	LED_Light4	34412	Virtual	<input type="button" value="Learn"/>
SELF	d50001	LED_Light5	420953	Virtual	<input type="button" value="Learn"/>
SELF	d50001	LED_Light6	413631	Virtual	<input type="button" value="Learn"/>
SELF	d50001	LED_Light7	420621	Virtual	<input type="button" value="Learn"/>
SELF	d50001	Round_Light1	41360	Virtual	<input type="button" value="Learn"/>
SELF	d50001	Round_Light10	413623	Virtual	<input type="button" value="Learn"/>
SELF	d50001	Round_Light11	4205	Virtual	<input type="button" value="Learn"/>
SELF	d50001	Round_Light12	4202	Virtual	<input type="button" value="Learn"/>
SELF	d50001	Round_Light2	413707	Virtual	<input type="button" value="Learn"/>
SELF	d50001	Round_Light3	41331	Virtual	<input type="button" value="Learn"/>
SELF	d50001	Round_Light4	41351	Virtual	<input type="button" value="Learn"/>
SELF	d50001	Round_Light5	41365	Virtual	<input type="button" value="Learn"/>
SELF	d50001	Round_Light6	413163	Virtual	<input type="button" value="Learn"/>
SELF	d50001	Round_Light7	413608	Virtual	<input type="button" value="Learn"/>
SELF	d50001	Round_Light8	4137145	Virtual	<input type="button" value="Learn"/>
SELF	d50001	Round_Light9	41363	Virtual	<input type="button" value="Learn"/>

Link Table Edit and Save

Click **Stop Discovery** when your devices are discovered.

Stop Discovery
EURID
04136f49
0420b953
042072c1
04136f31
04206217

After you click **Stop Discovery**, you will see a form which allows you to work with the discovered devices. Click the **Locate** button to have the EnOcean device toggle its state to help you verify that you have selected the correct device. For example, if this is an EnOcean relay it will toggle the relay on and off. Click the **Download Link Table** button to view and modify the Link Table in this device. This will take about 30 seconds to complete.

EURID	UNLOCK	Actions
04136f49	<input type="text" value="56657276"/> <input type="button" value="Unlock"/> <input type="button" value="Reset"/>	<input type="button" value="Locate"/> <input type="button" value="Download Link Table"/> <input type="button" value="Remote Configuration"/>
0420b953	<input type="text" value="56657276"/> <input type="button" value="Unlock"/> <input type="button" value="Reset"/>	<input type="button" value="Locate"/> <input type="button" value="Download Link Table"/> <input type="button" value="Remote Configuration"/>
042072c1	<input type="text" value="56657276"/> <input type="button" value="Unlock"/> <input type="button" value="Reset"/>	<input type="button" value="Locate"/> <input type="button" value="Download Link Table"/> <input type="button" value="Remote Configuration"/>
04136f31	<input type="text" value="56657276"/> <input type="button" value="Unlock"/> <input type="button" value="Reset"/>	<input type="button" value="Locate"/> <input type="button" value="Download Link Table"/> <input type="button" value="Remote Configuration"/>
04206217	<input type="text" value="56657276"/> <input type="button" value="Unlock"/> <input type="button" value="Reset"/>	<input type="button" value="Locate"/> <input type="button" value="Download Link Table"/> <input type="button" value="Remote Configuration"/>

When the Link Table appears, you can delete entries in the table by selecting a device in the table and then clicking the provided **Delete** button (unlink or delete will remove this entry). Then click the **Save changes to controller** button when prompted.

Link Table Edit and Save

Link table for device: 04136f49				
DIRECTION	INDEX	EURID	EEP	CHANNEL
00	00	fee8abd6	f60202	01
00	01	002c958f	f60202	00
00	02	0036dc1b	f60202	02
00	03	002c958f	f60202	01
00	04	051329d1	a53808	01

To add entries to the Link Table, select devices in your Registered Devices list. After selecting a device, it should appear in the Link Table on the webpage. Click **Save changes to controller** to complete the process. If you select a real EnOcean device, this device can be used to control this EnOcean device. Make sure you select a device which is compatible with your device. If you select a virtual device, then the gateway can be used to control the remote commissionable EnOcean device.

You can use the **Remote Configuration** button to configure the settings in EnOcean devices that support this feature. If the option is grayed out, then this is not supported on the EnOcean device, or the gateway does not contain a compatible DDF file for this device. Request this file from your device manufacturer and Contemporary Controls can assist in getting this into the gateway. Once selected, a new webpage will appear which will allow you to configure the settings of the remote configurable device. Click the **include in the next get/set operation** checkbox for any changed values. Then click the **Set Device Configuration** button to store these settings to the EnOcean device.

Click the **Configure Virtual EnOcean Output Devices** button at the bottom of the page. This will open the Virtual Output Device Registration page.

[Configure Virtual EnOcean Output Devices](#)

6.4.1 Virtual Output Device Registration Page

You can add or delete virtual EnOcean output devices on the Virtual Output Device Registration page. The gateway provides two types of BACnet devices. When you add sensor type devices or EnOcean devices which normally only transmit, the gateway will create BACnet devices that carry the EnOcean data transmitted by these devices and received by the gateway. This BACnet device will have read-only BACnet object types (Analog Input, Binary Input, Multistate Input, etc.). The second type of BACnet device is the virtual EnOcean output device. The virtual EnOcean output device is a BACnet device that, when written via BACnet, will cause the gateway to transmit EnOcean data. This BACnet device will have BACnet objects which can be written (Analog Output, Binary Output, Multistate Output, etc.). The virtual EnOcean output device would be used to control EnOcean devices which can receive EnOcean transmissions. For example, the gateway can be used to control the EnOcean Inc., LEDRU relay.

EnOcean Virtual Output Device Registration

Register EnOcean Virtual Device by filling out the following form:

EEP : Select EEP

BACnet ID : Enter Unique BACnet ID between 0 and 4194303

Name : Enter Name for the Device

Dest Eurid : Enter Destination EURID

Registered EnOcean Virtual Output Devices

EURID	EEP	Name	BACnet ID	Destination
Self	d50001	LEDRU	64523	0412747c
Self	d50001	LED_Light1	65432	041274c2
Self	d50001	LED_Light2	24315	042070ae
Self	d50001	LED_Light3	525334	04139d4f
Self	d50001	LED_Light4	34412	0413aff7
Self	d50001	Round_Light1	41360	04136dc0
Self	d50001	Round_Light2	413707	041370a7
Self	d50001	Round_Light3	41331	04133e1f
Self	d50001	Round_Light4	41351	04135a1a
Self	d50001	Round_Light5	41365	04136db5
Self	d50001	Round_Light6	413163	04131f63
Self	d50001	Round_Light7	413608	04136d08
Self	d50001	Round_Light8	4137145	04137145
Self	d50001	Round_Light9	41363	04136f3a
Self	d50001	Round_Light10	413623	0413b623
Self	d50001	Round_Light11	4205	0420bd5d
Self	d50001	Round_Light12	4202	0420C2BC
Self	d50001	LED_Light5	420953	0420b953
Self	d50001	LED_Light6	413631	04136f31
Self	d50001	LED_Light7	420621	04206217

Device Details

Click on any row in the registered EnOcean Virtual Output Devices table to see details here

When creating the virtual output device, you need to select an EEP for this virtual device. This EEP must be compatible with the EnOcean devices you wish to control from the gateway. These can be remote commissionable EnOcean devices or standard EnOcean output devices that you wish to control from the gateway.

The entered unique BACnet ID or BACnet object instance will be the value used by the gateway when it creates this virtual BACnet device. The name field is the unique BACnet object name to be used. The Destination EURID is the EURID to which the EnOcean messages will be transmitted when the BACnet objects are written. You can enter the default broadcast address of "FFFFFFF" which will be received by all EnOcean devices. Or you can enter a single EURID. Once entered it will appear in the registered EnOcean Virtual Output devices list and it can be discovered on the BACnet network.

The gateway will only control the EnOcean devices to which it has been bound or linked. If you use a broadcast address, then you can control multiple linked EnOcean devices from one virtual output

device. If you use a single EURID address, then the virtual output device will only control one bound/linked EnOcean device.

An output EEP is for a device that receives EnOcean messages. The gateway transmits to these devices using an EEP selected from a list of supported output EEPs.

The gateway masquerades as one of these device types so it can control the EnOcean device. For example, if the gateway masquerades as a D5-00-01, it can control a large number of EnOcean devices, e.g., EnOcean relays. The gateway controls these devices based on BACnet messages it receives to its created virtual BACnet device. For example, when the gateway's virtual BACnet binary output receives a TRUE, the gateway will transmit a message as a D5-00-01, and this will turn on an EnOcean relay which is linked to the gateway.

The list of output EEPs is short. These are the most popular EEPs which are typically used to control EnOcean output devices.

NOTE: More input and output EEPs can be added upon customer request provided they do not require Smart Acknowledge.

EnOcean to BACnet Gateway Supported Output EEPs
A5-04-03
A5-02-03
A5-3F-7F
A5-38-08
D2-14-41
D5-00-01
F6-02-02

EEPs are defined by the EnOcean Alliance. The gateway contains files which provide a list of BACnet objects that correspond to the values in an EnOcean message for the EEP. For example, a D5-00-01 EEP virtual output device will have 3 objects. The Analog Value-2 can be ignored as these are only for input devices. When a BACnet client writes the Binary Output-1 object then the gateway will transmit an EnOcean message for this virtual device. The destination of the message will be the EURID provided during configuration of this virtual device. The EnOcean message will only be transmitted when all the output BACnet objects are written for the virtual device. In the case of the D5-00-01 there is only one object.

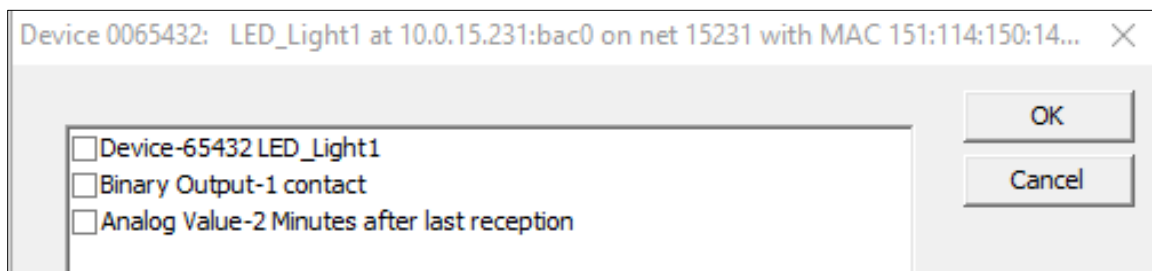

If you use an EEP like the A5-38-08 then you will see many BACnet objects in its list of objects. However, this type of EEP is a special EEP and only a subset of objects are needed to be written in order for an EnOcean transmission to occur. The A5-38-08 has a command object. This object indicates the type of EnOcean message and only the objects in the group need to be written. If you look at the object names you can see a two-character indication followed by a colon, "SW," "DG," "SS," "BS," "CV," "FS," and "BC." All objects in the same group have the same two-character indication. If you wish to use the "SW" features of the EnOcean device, then write a "1" to the Command object and then write a

value to all of the “SW” objects. After the last object is written, the gateway will transmit an EnOcean message carrying data for the SW features of the EnOcean device. If you wish to write to the “DG” features of the EnOcean device, write a “2” to the Command object and then write to all of the DG objects, and an EnOcean message will be transmitted carrying data for the DG features of the EnOcean device.

Command Value	Group
1	SW
2	DG
3	SS
4	BS
5	CV
6	FS
7	BC

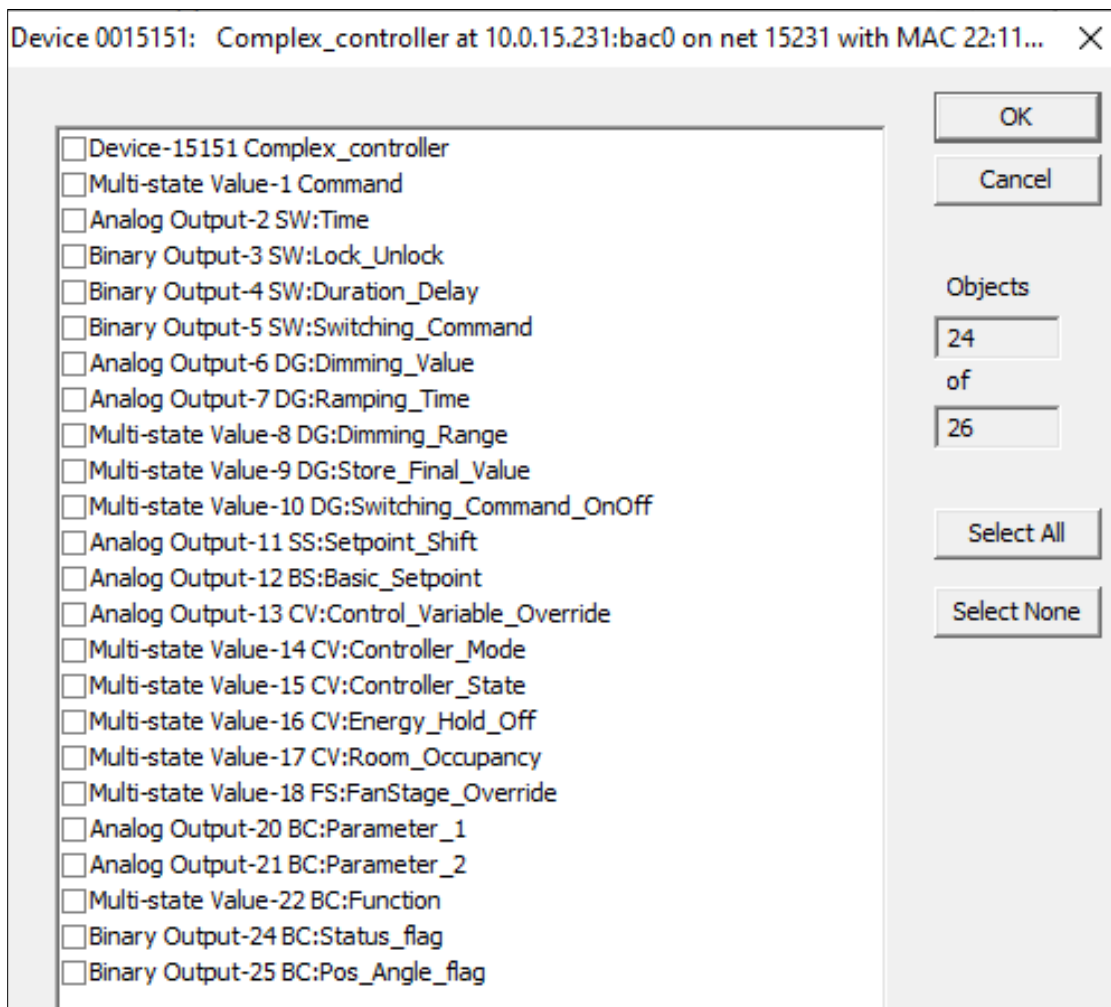

6.5 Mapping Status

The Mapping Status webpage will show the status of the EnOcean devices which have been entered into the gateway. Select the device from the **Device Instance** drop-down. You can then select an object from the list of objects and select **Present Value** and click the **Read** button to see its current state from the last transmission of the corresponding EnOcean device. You can also use this to write values to EnOcean output devices which are entered into the gateway by selecting the appropriate object instance (with object property set to Present Value) and entering the appropriate property value and clicking the **Write** button. The Unit status box shows the last time a message was received by the gateway from this EnOcean device. If a message has been received, the text will be green, otherwise the text will be black. The EnOcean virtual output devices will appear in this list but will not have any status.

The screenshot shows the 'Mapping Status' webpage. At the top, the title 'Mapping Status' is displayed in red. Below the title, there are four input fields: 'Device Instance' (a dropdown menu showing '403151: temperature_sensor'), 'EnOcean Address (Hex)' (a text box containing '051C32F8'), 'Object Instance' (a dropdown menu showing '1: AI : temperature'), and 'Object Property' (a dropdown menu showing 'Present Value'). Below these fields is a 'Property Value' text box. Underneath the text boxes are two buttons: 'READ' and 'WRITE'. At the bottom of the page is a 'Unit Status' section, which is a scrollable area containing a list of device instances. The first line is highlighted in green and reads: 'EURID 051C32F8 Device Instance 0403151 Last Reception 14 minutes ago'. The following lines are in black and list other device instances with their EURID, Device Instance, and Instance values.

EURID	Device Instance	Instance	Last Reception
051C32F8	0403151	14 minutes ago	
0413D69F	0151232		
94967296	0064523		
94967297	0065432		
94967298	0024315		
94967299	0525334		
94967300	0034412		
94967313	0420953		
94967314	0413631		
94967315	0420621		
94967301	0041360		
94967310	0413623		
94967311	0004205		
94967312	0004202		

6.6 Upload/Download

The upload/download menu allows the firmware of the gateway to be updated via the webpage. Follow the instructions on the webpage. Backup/Restore allows the settings to be saved and restored for the gateway. Upload EnOcean Devices allows the uploading of a CSV file to define all of the EnOcean devices in the gateway. Contact Contemporary Controls for the format of this CSV file. After the CSV file has been uploaded the "Add Devices" webpage will show the loading of these EnOcean devices into the gateway.

7 Using the Gateway to Control LEDRU

The gateway can be used to control EnOcean relay devices such as EnOcean Inc.'s LEDRU. As this device supports remote commissioning our example will make the link to the LEDRU via remote commissioning.

- 1 Create the virtual EnOcean Output Device. Go to the Remote Commissioning webpage. Click the **Configure Virtual EnOcean Output Devices** button. Select your desired EEP. A D5-00-01 is a simple EEP that can be used to turn on/off the relay by writing one BACnet object. The A5-38-08 is also supported by the LEDRU and will allow more functions to be controlled on the LEDRU but it will require more BACnet objects to be written. Enter a unique BACnet ID and Name. Enter the destination EURID. If you don't know your EURID you can find this from the Remote Commissioning webpage, perform a discovery, click the **Locate** button for each device and then copy the EURID for the device which is activated by the Locate command. Or you can use a broadcast (FFFFFFFF) EURID. This will cause all devices which are bound/linked to the gateway to be controlled at the same time. Then click the **Register** button. You should then see your virtual output device in the list below. You will need to reboot the gateway before this virtual output device is active (Upload/Download->Backup/Restore->Update).
- 2 Download Link Table of LEDRU. Go to the Remote Commissioning webpage. Enter the unlock code for the LEDRU or use the default one provided. Click **Start Discovery**. When your LEDRU appears, click **Stop Discovery**. Then click the **Download Link Table** button for your LEDRU. Select the device you created in step 1. You should then be presented with the option to add this to the Link Table. You can enter a channel ID of 0 and use the Inbound direction for most applications. Click **Add Device** and you should see this device in the Link Table. Click **Save Changes to Controller** to save this change to the LEDRU.
- 3 Reboot the gateway (see step 1). Go to the Mapping Status page. Select the device you created in the device instance drop down. If you used the D5-00-01 EEP select the contact object. Enter 0 in the property value box and click the **Write** button. Then enter the 1 in the property box and click the **Write** button. These should toggle the state of the LEDRU. If you used the A5-38-08 EEP you will need to write to the command object and the corresponding group objects for that command.

If you are not using a remote commissionable EnOcean output device, you can still link the gateway to the device by applying step 1 and for step 2 use manual binding by putting the output device in link mode (see manufacturer instructions) and click the **Learn** button on the remote commissioning page for the device created in step 1. Step 3 should work the same way. You can also use manual binding with an LEDRU.

8 BACnet Protocol Implementation Conformance Statement (PICS)



EnOcean to BACnet Gateway

BACnet Protocol Implementation Conformance Statement (Annex A)

Date: April 15, 2024

Vendor Name: Contemporary Controls

Product Name: EnOcean to BACnet Gateway

Product Model Number: BASGE-EN868 or BASGE-EN902

Applications Software Version: 2.0 **Firmware Revision:** 2.0 **BACnet Protocol Revision:** 14

Product Description: EnOcean to BACnet/IP gateway.

BACnet Standardized Device Profile (Annex L):

<input type="checkbox"/> BACnet Operator Workstation (B-OWS)	<input type="checkbox"/> BACnet Advanced Application Controller (B-AAC)
<input type="checkbox"/> BACnet Advanced Operator Workstation (B-AWS)	<input checked="" type="checkbox"/> BACnet Application Specific Controller (B-ASC)
<input type="checkbox"/> BACnet Operator Display (B-OD)	<input type="checkbox"/> BACnet Smart Sensor (B-SS)
<input type="checkbox"/> BACnet Building Controller (B-BC)	<input type="checkbox"/> BACnet Smart Actuator (B-SA)

List all BACnet Interoperability Building Block Supported (Annex K):

DS-RP-B Data Sharing — ReadProperty – B	DM-DDB-B Device Management — Dynamic Device Binding – B
DS-WP-B Data Sharing — WriteProperty – B	DM-DOB-B Device Management — Dynamic Object Binding – B
DS-RPM-B Data Sharing — ReadPropertyMultiple – B	DM-DCC-B Device Management — Device Communication Control – B
DS-COV-B Data Sharing — ChangeOfValue – B	

Segmentation Capability:

<input type="checkbox"/> Able to transmit segmented messages	Window Size:
<input type="checkbox"/> Able to receive segmented messages	Window Size:

Standard Object Types Supported:

Object Type Supported	Can Be Created Dynamically	Can Be Deleted Dynamically
Analog Input	No	No
Analog Output	No	No
Binary Input	No	No
Binary Output	No	No
Device	No	No
Analog Value	No	No
Multistate Value	No	No

No optional properties are supported.

Data Link Layer Options:

<input checked="" type="checkbox"/> BACnet IP, (Annex J)	<input type="checkbox"/> MS/TP slave (Clause 9), baud rate(s):
<input checked="" type="checkbox"/> BACnet IP, (Annex J), Foreign Device	<input type="checkbox"/> Point-To-Point, EIA 232 (Clause 10), baud rate(s):
<input type="checkbox"/> ISO 8802-3, Ethernet (Clause 7)	<input type="checkbox"/> Point-To-Point, modem, (Clause 10), baud rate(s):
<input type="checkbox"/> ATA 878.1, 2.5 Mb, ARCNET (Clause 8)	<input type="checkbox"/> LonTalk, (Clause 11), medium:
<input type="checkbox"/> ATA 878.1, EIA-485 ARCNET (Clause 8), baud rate(s):	<input type="checkbox"/> BACnet/Zigbee (Annex O)
<input type="checkbox"/> MS/TP master (Clause 9), baud rate(s):	<input type="checkbox"/> Other:

Device Address Binding:
Is static device binding supported? (This is currently necessary for two-way communication with MS/TP slaves and certain other devices.) Yes No

Networking Options:

<input type="checkbox"/> Router, Clause 6 — List all routing configurations, e.g., ARCNET-Ethernet, Ethernet-MS/TP, etc.
<input type="checkbox"/> Annex H, BACnet Tunnelling Router over IP
<input type="checkbox"/> BACnet/IP Broadcast Management Device (BBMD)
Does the BBMD support registrations by Foreign Devices? <input type="checkbox"/> Yes <input type="checkbox"/> No
Does the BBMD support network address translation? <input type="checkbox"/> Yes <input type="checkbox"/> No

Character Sets Supported:
Indicating support for multiple character sets does not imply that they can all be supported simultaneously.

<input checked="" type="checkbox"/> ISO 10646 (UTF-8)	<input type="checkbox"/> IBM™/Microsoft™ DBCS	<input type="checkbox"/> ISO 8859-1
<input type="checkbox"/> ISO 10646 (UCS-2)	<input type="checkbox"/> ISO 10646 (UCS-4)	<input type="checkbox"/> JIS X 0208

If this product is a communication gateway, describe the types of non-BACnet equipment/network(s) that the gateway supports:
EnOcean gateway support.

Network Security Options:

<input checked="" type="checkbox"/> Non-secure Device — is capable of operating without BACnet Network Security
<input type="checkbox"/> Secure Device — is capable of using BACnet Network Security (NS-SD BIBB)
<input type="checkbox"/> Key Server (NS-KS BIBB)



April 15, 2024
PI-ENOGTWY0-AA0

UM-BASGE902-AA0

Page 31

9 Warranty

Contemporary Controls (CC) warrants this product to the original purchaser for two years from the product shipping date. Product returned to CC for repair is warranted for one year from the date the repaired product is shipped back to the purchaser or for the remainder of the original warranty period, whichever is longer. If the product fails to operate in compliance with its specification during the warranty period, CC will, at its option, repair or replace the product at no charge. The customer is, however, responsible for shipping the product; CC assumes no responsibility for the product until it is received. CC's limited warranty covers products only as delivered and does not cover repair of products that have been damaged by abuse, accident, disaster, misuse, or incorrect installation. User modification may void the warranty if the product is damaged by the modification, in which case this warranty does not cover repair or replacement. This warranty in no way warrants suitability of the product for any specific application. IN NO EVENT WILL CC BE LIABLE FOR ANY DAMAGES INCLUDING LOST PROFITS, LOST SAVINGS, OR OTHER INCIDENTAL OR CONSEQUENTIAL DAMAGES ARISING OUT OF THE USE OR INABILITY TO USE THE PRODUCT EVEN IF CC HAS BEEN ADVISED OF THE POSSIBILITY OF SUCH DAMAGES, OR FOR ANY CLAIM BY ANY PARTY OTHER THAN THE PURCHASER. THE ABOVE WARRANTY IS IN LIEU OF ANY AND ALL OTHER WARRANTIES, EXPRESSED OR IMPLIED OR STATUTORY, INCLUDING THE WARRANTIES OF MERCHANTABILITY, FITNESS FOR PARTICULAR PURPOSE OR USE, TITLE AND NONINFRINGEMENT.

10 Returning Products for Repair

Return the product to the location where it was purchased by following the instructions at the URL: www.ccontrols.com/rma.htm

11 Declaration of Conformity

Additional compliance documentation can be found on our website: www.ccontrols.com

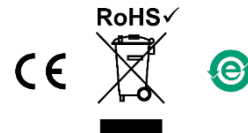

United States Contemporary Control Systems, Inc.	China Contemporary Controls (Suzhou) Co. Ltd	United Kingdom Contemporary Controls Ltd	Germany Contemporary Controls GmbH
Tel: +1-630-963-7070 Fax: +1-630-963-0109	Tel: +86 512 68095866 Fax: +86 512 68093760	Tel: +44 (0)24 7641 3786 Fax: +44 (0)24 7641 3923	Tel: +49 341 520359 0 Fax: +49 341 520359 16
info@ccontrols.com	info@ccontrols.com.cn	ccl.info@ccontrols.com	c cg.info@ccontrols.com
www.ccontrols.com			