

**CONTROLLER 48x96mm
VC-88 TYPE**



USER'S MANUAL



Contents:

1. APPLICATION	5
2. CONTROLLER SET	5
3. BASIC REQUIREMENTS, OPERATIONAL SAFETY	6
4. INSTALLATION	6
4.1. Controller Installation	6
4.2. Electrical Connections.....	8
4.3. Installation Recommendations.....	10
5. STARTING TO WORK	11
6. SERVICE	11
6.1. Programming Controller Parameters	13
6.2. Programming matrix.....	14
6.3. Setting Change	16
6.4. Parameter Description	17
7. CONTROLLER INPUTS AND OUTPUTS	31
7.1. Main Measuring Inputs	31
7.2. Additional Measuring Inputs	31
7.3. Binary Outputs.....	32
7.4. Outputs.....	33
8. CONTROL	34
8.1. ON-OFF Control.....	34
8.2. Innovative SMART PID algorithm	34
8.2.1. Auto-tuning.....	35
8.2.2. Auto-tuning and „Gain Scheduling”	37
8.2.3. Proceeding Way in Case of Dissatisfying PID Control.....	37
8.3. Stepper Control.....	39
8.4. “Gain Scheduling” Function	42
8.5. Control of Heating-cooling Type	43

9. ALARMS	44
10. TIMER FUNCTION	46
11. CURRENT TRANSFORMER INPUT	47
12. ADDITIONAL FUNCTIONS	49
12.1. Control Signal Monitoring.....	49
12.2. Manual Control	49
12.3. Signal Retransmission	50
12.4. Set Point Change Rate – Soft Start	51
12.5. Digital Filter.....	51
12.6. Manufacturer’s Settings.....	52
13. PROGRAMMING CONTROL	53
13.1. Description of Programming Control Parameters.....	53
13.2. Definition of Set Point Value Programs.....	56
13.3. Control of the Set Point Value Program	59
14. RS-485 INTERFACE WITH MODBUS PROTOCOL	61
14.1. Introduction	61
14.2. Error Codes.....	62
14.3. Register Map	62
15. SOFTWARE UPDATING	84
16. ERROR SIGNALING	86
17. TECHNICAL DATA	88
18. ORDERING CODES	93
19. MAINTENANCE AND GUARANTEE	93

(program version 2.04)

1. APPLICATION

The VC-88 controller is destined for the temperature control in plastics, food, dehydration industries and everywhere when the temperature change stabilization is necessary.

The measuring input is universal for resistance thermometers (RTD), thermocouple sensors (TC), or for linear standard signals.

The controller has four outputs enabling the two-step control, step-by-step three-step control, three-step control of heating-cooling type and alarm signaling. The two-step control is acc. to the PID or ON-OFF algorithm.

The innovative SMART PID algorithm has been implemented in the controller.

2. CONTROLLER SET

The delivered controller set is composed of:

1. VC-88 controller..... 1 pc
2. plug with 16 screw terminals..... 2 pcs
3. screw clamp to fix the controller in the panel..... 4 pcs
4. seal..... 1 pc
5. user's manual..... 1 pcs
6. guarantee card..... 1 pc

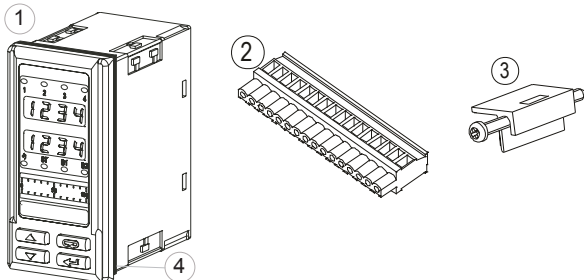

When unpacking the controller, please check whether the type and version code on the data plate correspond to the order.

3. BASIC REQUIREMENTS, OPERATIONAL SAFETY

In the safety service scope, the controller meets to requirements of the EN 61010-1 standard.

Observations Concerning the Operational Safety:



- All operations concerning transport, installation, and commissioning as well as maintenance, must be carried out by qualified, skilled personnel, and national regulations for the prevention of accidents must be observed.
- Before switching the controller on, one must check the correctness of connections to the network.
- Do not connect the controller to the network through an autotransformer.
- The removal of the controller casing during the guarantee contract period may cause its cancellation.
- The controller fulfills requirements related to electromagnetic compatibility in the industrial environment
- When connecting the supply, one must remember that a switch or a circuit-breaker should be installed in the room. This switch should be located near the device, easy accessible by the operator, and suitably marked as an element switching the controller off.
- Non-authorized removal of the casing, inappropriate use, incorrect installation or operation, create the risk of injury to personnel or controller damage.

For more detailed information, please study the User's Manual.

4. INSTALLATION

4.1. Controller Installation

Fix the controller in the panel, which the thickness should

not exceed 15 mm, by means of four screw clamps acc. to the fig. 1.
The panel cut-out should have $45^{+0,6} \times 92^{+0,6}$ mm.

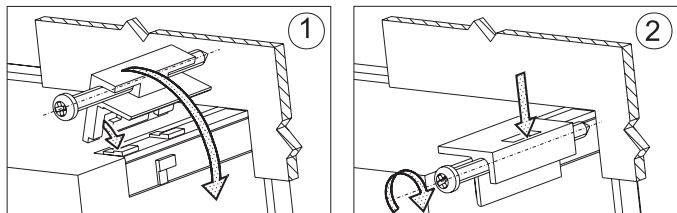

Fig.1 Controller fixing in the panel

VC-88 controller overall dimensions are presented on the fig. 2.

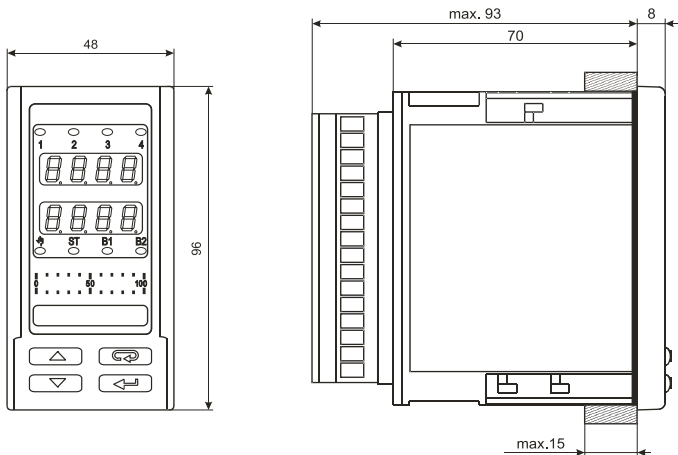

Fig. 2. Controller dimensions.

4.2. Electrical Connections

The controller has two separable terminal strips with screw terminals. Strips enable to connect all signals by a wire of 2.5 mm² cross-section.

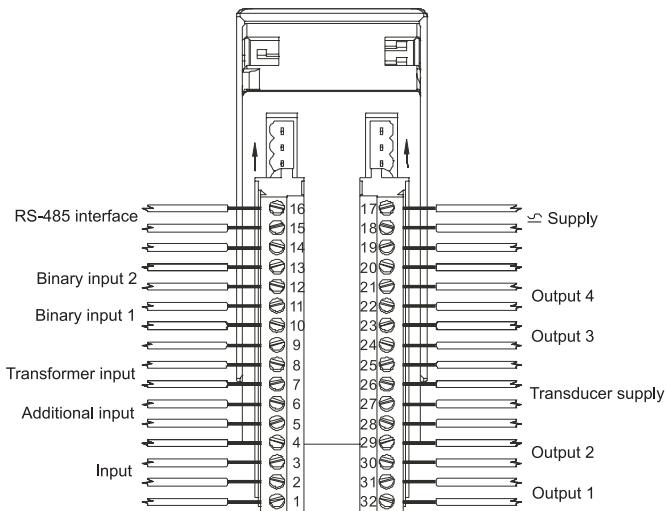

Fig. 3. View of controller connecting strips.

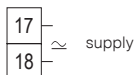

Fig. 4. Supply.

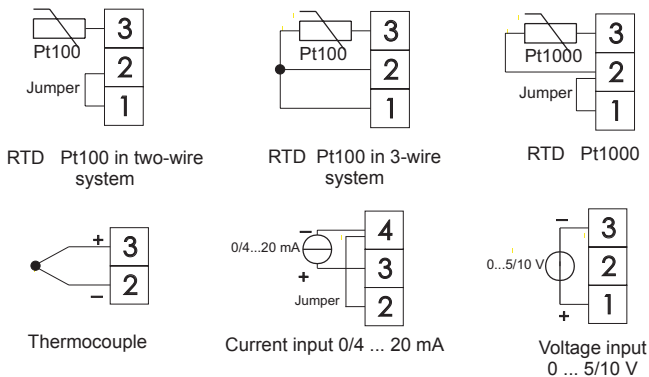

Fig. 5. Input signals.

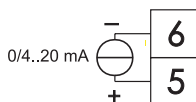

Fig. 6. Additional input signal.

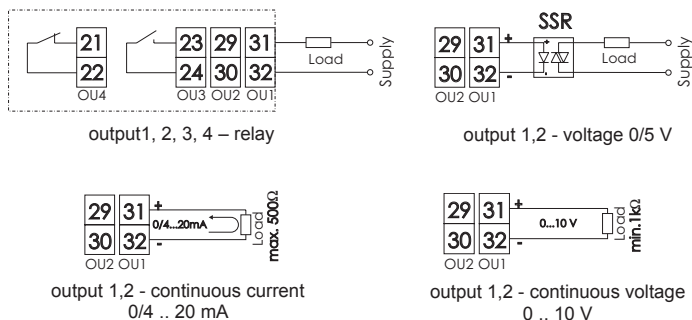

Fig. 7. Control outputs/alarm.

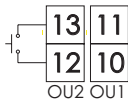

Fig. 8. Binary input 1 and 2

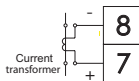

Fig. 9. Current transformer input.

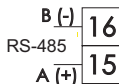

Fig. 10. RS-485 Interface



Fig. 11. Transducer supply 24V

4.3. Installation Recommendations

In order to obtain a full fastness against electromagnetic noise, it is recommended to observe following principles:

- do not supply the controller from the network in the proximity of devices generating high pulse noises and do not apply common earthing circuits,
- apply network filters,
- wires leading measuring signals should be twisted in pairs, and for resistance sensors in 3-wire connection, twisted of wires of the same length, cross-section and resistance, and led in a shield as above,
- all shields should be one-side earthed or connected to the protection wire, the nearest possible to the controller,
- apply the general principle, that wires leading different signals should be led at the maximal distance between them (no less than 30 cm), and the crossing of these groups of wires made at right angle (90°).





5. STARTING TO WORK

After turning the supply on, the controller carries out the display test, displays the **UC - 88**, inscription, the program version and next, displays the measured and set value.

A character message informing about abnormalities may appear on the display (table 18).

The PID control algorithm with the proportional range 30°C, a 300 seconds' integration time constant, a 60 seconds' differentiation time constant and a 20 seconds' pulse period are set by the manufacturer.

Changing the Set Point Value

One can change the set point value by pressing the  or  (push-button (fig. 12)). The beginning of change is signaled by the flickering dot of the lower display. One must accept the new set point value by holding down the  push-button during 30 seconds since the last pressure of the  or  push-button. In the contrary, the old value will be restored. The change limitation is set by parameters **SPLL** and **SPLH**.

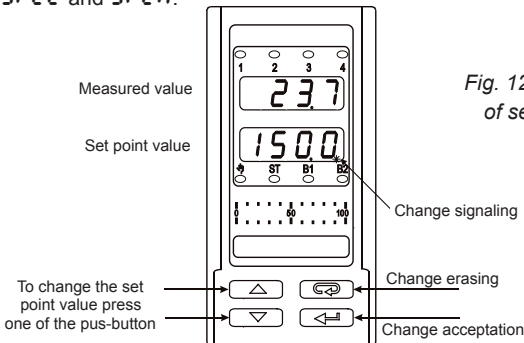

Fig. 12. Fast change of set point value

6. SERVICE

The controller service is presented on the fig. 13

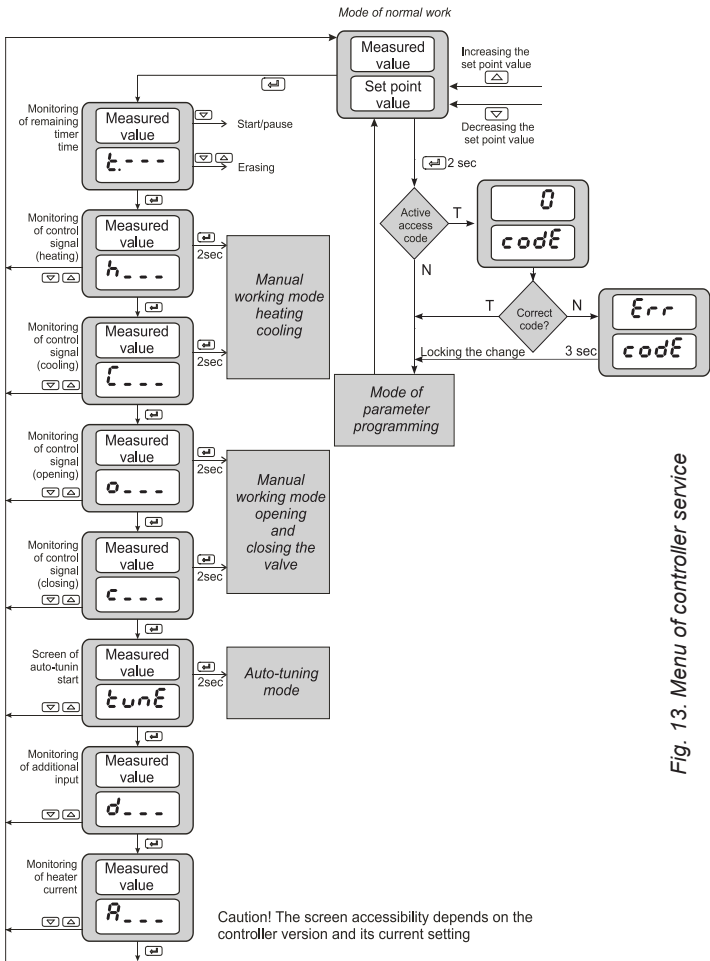









Fig. 13. Menu of controller service

6.1. Programming Controller Parameters

The pressure and holding down the  push-button during ca 2 sec. causes the entry in the programming matrix. The programming matrix can be protected by an access code. In case when giving a wrong value of the code, it is only possible to see settings through – without the possibility of changes.

The fig 14. presents the transition matrix in the programming mode. The transition between levels is carrying out by means of  or , push-buttons and the level selection by means of the  push-button. After selecting the level, the transition between parameters is carried out by means of  or  push-buttons. In order to change the parameter setting, one must proceed acc. to the section 6.3. In order to exit from the selected level, one must transit between parameters until the symbol [. . .] appears and press the  push-button.

In order to exit from the programming matrix to the normal working mode, one must transit between levels until the symbol [. . .] appears and press the  push-button.

Some controller parameters can be invisible – it depends on the current configuration.

The table 1 includes the description of parameters. The return to the normal working mode follows automatically after 30 seconds since the last push-button pressure.

6.2. Programming matrix





inP Input parameters	unit Unit	intY Kind of main input	dP Pos. of decimal point	indLo Indic. of lower threshold	indHi Indic. of higher threshold	SH.F Shift of measured value	intY Kind of auxiliary input	dP2 Pos. of decimal point	indLo Indic. of lower threshold
outP Output parameters	out1 Function of output 1	outY Type of output 1	out2 Function of output 2	outY Type of output 2	out3 Function of output 3	out4 Function of output 4	YFL Damage control signal	imp1 Impulse period Out 1	imp2 Impulse period Out 2
ctrl Control parameters	ALG Control algorithm	tyPE Kind of control	HY Hysteresis	Hn Deed zone	tnoo Valve opening time	tnoc Valve closing time	nteu Valve min. operation time	Y-Lo Min. control signal	Y-Hi Max. control signal
Pid PID Parameters	Submenu: P, d1				Submenu: P, d2, P, d3, P, d4		Submenu: P, dC		
	Pb Proportional band	ti Integration time constant	td Different time constant	YD Correc-tion of control signal	Parameters as for PID1		PbC Proportional band	tiC Integration time constant	tdC Different time constant
ALAR Alarm parameters	ALSP Set value for alarm 1	ALdu Deviation for alarm 1	ALHY Hysteresis for alarm 1	ALlt Memory of alarm 1	AL2P ... AL2t Parameters of alarm 2 (as for alarm 1)		AL3P ... AL3t Parameters of alarm 3 (as for alarm 1)		AL4P ... AL4t Param. of alarm 4 (as for alarm 1)
SP Parameters of set-point value	SPnd Kind of set-point value	CPrg Program No to carry out	SP Set value SP	SP2 Set value SP2	SP3 Set value SP3	SP4 Set value SP4	SPL Lower limitation SP	SPH Upper limitation SP	SPrr Accretion rate of set value
PrL Program control parameters	Description in programming control chapter								
retr Re-transmission param.	RAFn Re-transmis. function	RAlo Lower retransmis. threshold	RAHi Lower retransmis. threshold	Tr Transit to higher level					
intE Interface param.	RAdr Controller address	BRud Baud rate	Prot Transmis. protocol	Tr Transit to higher level					
SErv Service param.	SECU Access code	SEFn Auto-tuning function	timr Timer function	timE Count down of timer time	dip View of auxiliary output	dct View of the heater current	tout Exit time from view	bar1 Function of upper bargraph	bar2 Function of lower bargraph
...									
Exit from menu									

Fig. 14. Programming matrix

... Indic. of higher threshold	... Time constant of filter	... Binary input 1 function	... Transit to higher level							
... Impulse period Out 3	... Impulse period Out 4	... Transit of higher level								
... "Gain Scheduling" function	... Number of PID for GS	... Switching level PID1-2	... Switching level PID2-3	... Switching level PID3-4	... Constant PID set	... Lower threshold ST	... Upper threshold ST	... Reversible signal	... Transit to higher level	
... Transit to higher level										
... Parameters of alarm 4 (as for alarm 1)	... Set value of current alarm	... Hysteresis of current alarm	... Set value of current alarm	... Hysteresis of current alarm	... Transit to higher level					
... Transit to higher level										

... Lower threshold for bargraph	... Upper threshold for bargraph	... Transit to higher level
-------------------------------------	-------------------------------------	--------------------------------

6.3. Setting Change

The change of the parameter setting begins after pressing the  push-button during the display of the parameter name. The setting selection is carried out through  and  push-buttons, and accepted by the  push-button. The change cancellation follows after pressing of  push-button or automatically after 30 sec since the last push-button pressure.

The way to change the setting is shown on the fig. 15.

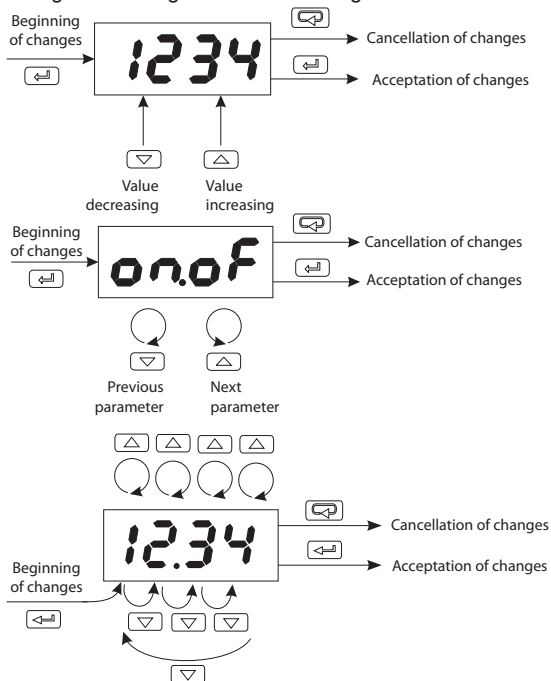

Fig. 15. Change of number, text and time parameter settings.

6.4. Parameter Description

The list of parameters in the menu is presented in the table 1.

List of configuration parameters

Table 1

Parameter symbol	Parameter description	Manufacturer setting	Range of parameter changes	
			Sensors	Linear input
Input parameters				
Unit	Unit	°C	°C : Celsius degrees °F : Fahrenheit degrees Pu : Physical units	
Main input	Kind of main input	Pt 1	Pt 1 : Pt100 Pt 10 : Pt1000 t - J : thermocouple J t - T : thermocouple T t - K : thermocouple K t - S : thermocouple S t - R : thermocouple R t - B : thermocouple B t - E : thermocouple E t - N : thermocouple N t - L : thermocouple L 0 - 20 : linear current 0-20mA 4 - 20 : linear current 4-20mA 0 - 5 : linear voltage 0-5 V 0 - 10 : linear voltage 0-10 V	
dP	Position of the main input decimal point	1 - dP	0 - dP : without decimal point 1 - dP : 1 decimal place	0 - dP : without decimal point 1 - dP : 1 decimal point 2 - dP : 2 decimal point

1. nL0	Indication for the lower threshold of the linear main input	0.0	-	-1999...9999 1)
1. nH1	Indication for the upper threshold of the linear main input	100.0	-	-1999...9999 1)
SH, F	Measured value shift of the main input	0.0 °C	-100.0...100.0 °C (-180.0...180.0 °F)	-999...999 1)
1. 2L Y	Kind of the auxiliary input	4-20	0-20 : linear current 0-20mA 4-20 : linear current 4-20mA	
dP2	Position of the decimal point	1-dP	-	0-dP : without decimal point 1-dP : 1 decimal point 2-dP : 2 decimal point
1. 2L0	Indication for the lower threshold of the auxiliary linear input	0.0	-	-1999...9999 1)
1. 2H1	Indication for the upper threshold of the auxiliary linear input	100.0	-	-1999...9999 1)
F, L t	Time constant of the filter	0.2	oFF : filter disabled 0.2 : time constant 0.2 s 0.5 : time constant 0.5 s 1 : time constant 1 s 2 : time constant 2 s 5 : time constant 5 s 10 : time constant 10 s 20 : time constant 20 s 50 : time constant 50 s 100 : time constant 100 s	

bin 1	Function of the binary input 1	none	none : none StoP : control stop HRnd : switching into manual working SP2 : switching SP1 into SP2 rSRt : erasing of timer alarm PStA : program start PnSt : jump to the next segment PHLd : stopping to count the set point in the program SP-d : decreasing of the set point value SP-u : increasing of the set point value i nSP : switching SP into additional input value
bin 2	Function of the binary input 2	none	none : none StoP : control stop HRnd : switching into manual working SP2 : switching SP1 into SP2 rSRt : erasing of timer alarm PStA : program start PnSt : jump to the next segment PHLd : stopping to count the set point in the program SP-d : decreasing of the set point value SP-u : increasing of the set point value i nSP : switching SP into additional input value
outP – Output parameters			
out 1	Function of output 1	y	oFF : without function y : control signal yOP : control signal for the stepper control – opening yCl : control signal for the stepper control - closing CoOL : control signal - cooling RAH : upper absolute alarm RLo : lower absolute alarm d uH : upper relative alarm

			<p><i>dul o</i>: lower relative alarm <i>dwr n</i>: inner relative alarm <i>duou</i>: outer relative alarm <i>RLtr</i>: timer alarm <i>rErr</i>: retransmission <i>Eu 1</i>: auxiliary output for the program-following control <i>Eu 2</i>: auxiliary output for the program-following control <i>Eu 3</i>: auxiliary output for the program-following control</p>
<i>o 1. t y</i>	Type of output 1	<i>4-20 2)</i>	<p><i>rEL y</i>: relay output <i>SSr</i>: voltage output 0/5 V <i>4-20</i>: continuous current output 4 – 20 mA <i>0-20</i>: continuous current output 0 – 20 mA <i>0- 10</i>: continuous voltage output 0 – 10 V</p>
<i>out 2</i>	Function of output 2	<i>oFF</i>	<p><i>oFF</i>: without function <i>y</i>: control signal <i>yOP</i>: control signal for the stepper control – opening <i>yCL</i>: control signal for the stepper control - closing <i>Co oL</i>: control signal - cooling <i>RM i</i>: upper absolute alarm <i>RL o</i>: lower absolute alarm <i>dwr n</i>: upper relative alarm <i>dul o</i>: lower relative alarm <i>dwr n</i>: inner relative alarm <i>duou</i>: outer relative alarm <i>RLtr</i>: timer alarm <i>RLhb</i>: heater damage alarm <i>RLoS</i>: controlling element damage alarm (short circuit) <i>rErr</i>: retransmission <i>Eu 1</i>: auxiliary output for the program-following control <i>Eu 2</i>: auxiliary output for the program-following control <i>Eu 3</i>: auxiliary output for the program-following control</p>

out2	Type of output 2	4-20 ²⁾	rELy : relay output 55r : voltage output 0/5 V 4-20 : current continuous output 4 – 20 mA 0-20 : current continuous output 0 – 20 mA 0-10 : voltage continuous output 0 – 10 V
out3	Function of output 3	off	off : without function y : control signal YOP : control signal for the stepper control – opening YCL : control signal for the stepper control - closing cool : control signal - cooling RH : upper absolute alarm RL : lower absolute alarm dUH : upper relative alarm dUL : lower relative alarm dwn : inner relative alarm dow : outer relative alarm RLtr : timer alarm RLhb : heater damage alarm RLoS : controlling element damage alarm (short circuit) rEtr : retransmission Ev1 : auxiliary output for the program-following control Ev2 : auxiliary output for the program-following control Ev3 : auxiliary output for the program-following control
out4	Function of output 4	off	off : without function y : control signal YOP : control signal for the stepper control – opening YCL : control signal for the stepper control - closing cool : control signal - cooling RH : upper absolute alarm RL : lower absolute alarm dUH : upper relative alarm dUL : lower relative alarm dwn : inner relative alarm dow : outer relative alarm RLtr : timer alarm RLhb : heater damage alarm

			ALOS : controlling element damage alarm (short circuit) RETR : retransmission EU1 : auxiliary output for the program-following control EU2 : auxiliary output for the program-following control EU3 : auxiliary output for the program-following control	
YFL	Control signal of control output for proportional control in case of the sensor damage.	0.0	0.0...100.0	
t01	Pulse period of output 1	20.0 s	0.5...99.9 s	
t02	Pulse period of output 2	20.0 s	0.5...99.9 s	
t03	Pulse period of output 3	20.0 s	0.5...99.9 s	
t04	Pulse period of output 4	20.0 s	0.5...99.9 s	
CTRL – Control parameters				
ALG	Control algorithm	P, d	onoff : control algorithm on-off P, d : control algorithm PID	
TYPE	Kind of control	cool	direct : direct control (cooling) reverse : reverse control (heating)	
HY	Hysteresis	1.1 °C	0.2...100.0 °C (0.2...180.0 °F)	
Hn	Displacement zone for heating-cooling control for dead zone for stepper control.	10.0 °C	0.0...100.0 °C (0.0...180.0 °F)	0...999 1)
t0vo	Valve open time	30.0 s	3.0...600.0 s	
t0vc	Valve close time	30.0 s	3.0...600.0 s	

ᠠᠨᠠᠲᠤ	Minimum valve work time	0,1 s	0.1...99.9 s
ᠶᠡᠯᠤ	Minimum control signal	0,0 %	0.0...100.0 %
ᠶᠡᠬᠡ	Maximum control signal	100.0 %	0.0...100.0 %
ᠭᠡᠲᠦ	“Gain Scheduling” function	᠔᠖᠖	᠔᠖᠖ : disabled ᠑᠓ : from the set point value ᠑ᠡᠡ : constant PID set
ᠭᠡᠰᠠᠨᠪᠤ	Number of PID sets for “Gain Scheduling” from the set point value	᠒	᠒ : 2 PID sets ᠓ : 3 PID sets ᠴ : 4 PID sets
ᠭᠡᠯᠡᠨᠠᠨᠠᠨᠠ	Switching levels for PID1 and PID 2 sets	0.0	MIN...MAX 3)
ᠭᠡᠯᠡᠨᠠᠨᠠᠨᠠ	Switching levels for PID2 and PID 3 sets	0.0	MIN...MAX 3)
ᠭᠡᠯᠡᠨᠠᠨᠠᠨᠠ	Switching levels for PID3 and PID 4 sets	0.0	MIN...MAX 3)
ᠭᠡᠰᠡᠡ	Selection of the constant PID set	᠓ᠡᠨᠠ	᠓ᠡᠨᠠ : PID1 sets ᠓ᠡᠨᠡ : PID2 sets ᠓ᠡᠨᠢ : PID3 sets ᠓ᠡᠨᠣ : PID4 sets
ᠰᠡᠯᠤ	Lower threshold for auto-tuning	0.0 °C	MIN...MAX 3)
ᠰᠡᠬᠡ	Upper threshold for auto-tuning	800.0 °C	MIN...MAX 3)
ᠶᠡᠳᠤ	Stepper control algorithm type	ᠠᠨᠠ	ᠠᠨᠠ : algorithm without feedback ᠶᠡᠰ : algorithm with feedback

P, d – PID parameters				
P, d 1	Pb	Proportional band	30.0 °C	0.1...550.0 °C (0.1...990.0 °F)
	t_i	Integration time constant	300 s	0...9999 s
	t_d	Differentiation time constant	60.0 s	0.0...2500 s
	Y0	Correction of the command signal, for P or control type PD	0.0 %	0...100.0 %
P, d 2	Pb2 t_i 2 t_d 2 Y02	Second set of PID parameters	as PB, TI, TD, Y0	
P, d 3	Pb3 t_i 3 t_d 3 Y03	Third set of PID parameters	as PB, TI, TD, Y0	
P, d 4	Pb4 t_i 4 t_d 4 Y04	Fourth set of PID parameters	as PB, TI, TD, Y0	
P, d C	PbC	Proportional range for cooling loop (in relation to PB)	100.0 %	0.1...200 %
	t_i C	Integration time constant	300 s	0...9999 s
	t_d C	Differentiation time constant	60.0 s	0.0...2500 s

<i>R1 Rr</i> – Alarm parameters			
<i>R1SP</i>	Set point value for absolute alarm 1	100.0	MIN...MAX ³⁾
<i>R1dU</i>	Deviation from the set point value for relative alarm 1	0.0 °C	-200.0... 200.0 °C (-360.0... 360.0 °F)
<i>R1HY</i>	Hysteresis for alarm 1	2.0 °C	0.2...100.0 °C (0.2...180.0 °F)
<i>R1Ll</i>	Memory of alarm 1	oFF	oFF : disabled oN : enabled
<i>R2SP</i>	Set point value for absolute alarm 2	100.0	MIN...MAX ³⁾
<i>R2dU</i>	Deviation from the set point value for relative alarm 2	0.0 °C	-200.0... 200.0 °C (-360.0... 360.0 °F)
<i>R2HY</i>	Hysteresis for alarm 2	2.0 °C	0.2...100.0 °C (0.2...180.0 °F)
<i>R2Ll</i>	Memory of alarm 2	oFF	oFF : disabled oN : enabled
<i>R3SP</i>	Set point value for absolute alarm 3	100.0 °C	MIN...MAX ³⁾
<i>R3dU</i>	Deviation from the set point value for relative alarm 3	0.0 °C	-200.0... 200.0 °C (-360.0... 360.0 °F)
<i>R3HY</i>	Hysteresis for alarm 3	2.0 °C	0.2...100.0 °C (0.2...180.0 °F)
<i>R3Ll</i>	Memory of alarm 3	oFF	oFF : disabled oN : enabled

А4SP	Set point value for absolute alarm 4	100.0 °C	MIN...MAX ³⁾
А4dU	Deviation from the set point value for relative alarm 4	0.0 °C	-200.0... 200.0 °C (-360.0... 360.0 °F)
А4HY	Hysteresis for alarm 4	2.0 °C	0.2...100.0 °C (0.2...180.0 °F)
А4LE	Memory of alarm 4	OFF	OFF : disabled ON : enabled
h6SP	Set point for the heater damage alarm	0.0 A	0.0...50.0 A
h6HY	Hysteresis for the heater damage alarm	0.1 A	0.1...50.0 A
o5SP	Set point for the controlling element damage alarm (short-circuit)	0.0 A	0.0...50.0 A
o5HY	Hysteresis for the controlling element damage alarm (short-circuit)	0.1 A	0.1...50.0 A
SPP – Set point value parameters			
SP.nd	Kind of set point value	SP 1.2	SP 1.2 : set point value SP1 or SP2 r.n.n : set point value with soft start in units per minute r.Hr : set point value with soft start in units per hour i.n2 : set point value from the additional input P.r.G : set point value from programming control SP.n : set point value SP or from the additional input
CP.r.G	Program No to carry out	1	1...15

SP	Set point value SP	0.0 °C	MIN...MAX ³⁾	
SP2	Set point value SP2	0.0 °C	MIN...MAX ³⁾	
SP3	Set point value SP3	0,0 °C	MIN...MAX ³⁾	
SP4	Set point value SP4	0.0 °C	MIN...MAX ³⁾	
SPL	Lower limitation of the fast set point value change	-200 °C	MIN...MAX ³⁾	
SPH	Upper limitation of the fast set point value change	1767 °C	MIN...MAX ³⁾	
SPrr	Accretion rate of the set point value SP1 or SP2 during the soft start.	0.0 °C	0...999.9 / time unit ⁴⁾	0...9999 ¹⁾ / time unit ⁴⁾
PrG – Programming control parameters				
The description of parameters is in the table 5: Programming control				
intE – Serial interface parameters				
Addr	Device address	1	1...247	
brud	Baud rate	96	48 : 4800 bit/s 96 : 9600 bit/s 192 : 19200 bit/s 384 : 38400 bit/s 576 : 57600 bit/s	
Prot	Protocol	r8n2	none : none r8n2 : RTU 8N2 r8E1 : RTU 8E1 r8o1 : RTU 8O1 r8n1 : RTU 8N1	

rEtR – Retransmission parameters			
Rofn	Quantity retransmitted on the continuous output	Pu	Pu : measured value on the main input PV Pu2 : measured value on the additional input PV2 P1-2 : measured value PV - PV2 P2-1 : measured value PV2 – PV SP : set point value du : control deviation (set point value – measured value)
Ralo	Lower threshold of the signal to retransmit	0.0	MIN...MAX 3)
Rohi	Upper threshold of the signal to retransmit	100.0	MIN...MAX 3)
SErP – Service parameters			
SECU	Access code to the menu	0	0...9999
Stfn	Auto-tuning function	on	off : locked on : available
tinr	Timer function	off	off : disabled on : enabled
tinE	Recounting time by the Timer	30.0 min	0.1...999.9 min
d2	Monitoring of the auxiliary input	off	off : disabled on : enabled
dct	Monitoring of the heater current	off	off : disabled on : enabled
tout	Time of the automatic exit from the monitoring mode	30 s	0...9999 s

bArl	Function of the upper bargraph	Pv	Pv : measured value on the main input PV Pv2 : measured value on the additional input PV2 SP : set point value Y1 : control signal on the output 1 Y2 : control signal on the output 2 S-t-n : segment time P-t-n : program time
bAr2	Function of the lower bargraph	SP	Pv : measured value on the main input PV Pv2 : measured value on the additional input PV2 SP : set point value Y1 : control signal on the output 1 Y2 : control signal on the output 2 S-t-n : segment time P-t-n : program time
bArL	Lower threshold for bargraphs (for PV, PV2 and SP)	0 °C	MIN...MAX 3)
bArH	Upper threshold for bargraphs (for PV, PV2 and SP)	1767 °C	MIN...MAX 3)

- 1) The definition at which the given parameter is shown depends on the parameter **dP** – position of the decimal point.
- 2) For the output 0/4...20 mA, parameter to write, for other cases, to readout – acc. to the version code.
- 3) See table 2.
- 4) Time unit defined by the parameter **SP.nd (r.n, n, r.Hr)**.

Caution! The accessibility of parameters depends on the controller version and its current settings.

Symbol	Input/ sensor	MIN	MAX
$Pt\ 1$	Thermoresistor Pt100	-200 °C (-328 °F)	850 °C (1562 °F)
$Pt\ 10$	thermoresistor Pt1000	-200 °C (-328 °F)	850 °C (1562 °F)
$t\ -J$	Thermocouple of J type	-100 °C (-148 °F)	1200 °C (2192 °F)
$t\ -t$	Thermocouple of T type	-100 °C (-148 °F)	400 °C (752 °F)
$t\ -k$	Thermocouple of K type	-100 °C (-148 °F)	1372 °C (2501,6 °F)
$t\ -S$	Thermocouple of S type	0 °C (32 °F)	1767 °C (3212,6 °F)
$t\ -R$	Thermocouple of R type	0 °C (32 °F)	1767 °C (3212,6 °F)
$t\ -B$	Thermocouple of B type	0 °C (32 °F)	1767 °C (3212,6 °F)
$t\ -E$	Thermocouple of E type	-100 °C (-148 °F)	1000 °C (1832 °F)
$t\ -N$	Thermocouple of N type	-100 °C (-148 °F)	1300 °C (2372 °F)
$t\ -L$	Thermocouple of L type	-100 °C (-148 °F)	800 °C (1472 °F)
$0\ -20$	Linear current 0-20mA	-1999 1)	9999 1)
$4\ -20$	Linear current 4-20 mA	-1999 1)	9999 1)
$0\ -10$	Linear voltage 0-10 V	-1999 1)	9999 1)

1) The definition at which the given parameter is shown depends on the parameter dP – position of the decimal point.

7. CONTROLLER INPUTS AND OUTPUTS

7.1. Main Measuring Inputs

The main input is the source of measured value taking part in control and alarms.

The main input is an universal input, to which one can connect different types of sensors or standard signals. The selection of the input signal type is made by the parameter $\nu 1 \text{ Y}$.

The position of the decimal point which defines the display format of the measured and the set point value is set by the parameter σP . For linear inputs, one must set the indication for the lower and upper analog input threshold $\nu 1 0$ and $\nu 1 \text{ H}$.

The correction of the measured value indication is carried out by the parameter 5 h , F .

7.2. Additional Measuring Inputs

The additional input can be the source of remote set point value ($5 P \text{ n}$ set on $\nu 2$) or the signal for retransmission ($R \sigma F \text{ n}$ set on $P \text{ y}$).

The additional input is a linear input. The selection of the input signal type is possible between 0...20 mA and 4...20 mA by the parameter $\nu 2 \text{ Y}$. The position of decimal point which defines the display format of the measured and set point value is set by the parameter σP . One must also set the indication for the lower and upper analog input threshold, $\nu 2 0$ and $\nu 2 \text{ H}$.

The signal from the additional input is displayed with the character „ σ ” on the first position. To display the value, one must hold down

the  push-button till the moment of its appearance on the lower display (acc. to the fig. 13.) The return to display the set point value is set by the manufacturer for 30 sec, but it can be changed, or disabled by the parameter `tout`.

7.3. Binary Inputs

Functions of binary input are set by `bn1 1` and `bn1 2` parameters. For each input must be set a different function.

Following binary input functions are available:

- **without functions** – the binary input state does not influence the controller operation,
- **control stop** – the control is interrupted, and control outputs are behaved as after a sensor damage, alarm and retransmission operate independently,
- **switching on manual operation** – transition to the manual control mode'
- **switching SP on SP2** – change of the set point value during the control,
- **erasing of the timer alarm** – disabling of the relay responsible for the timer alarm,
- **program start** – the programming control process begins (after a prior set of the programming control),
- **jump to the next segment** – the transition to the next segment follows, during the duration of the programming control
- **stoppage to count the set point value in the program** – the stoppage of set point value counting follows, during the duration of the programming control

- **change of the set point value** – after the configuration of two inputs, one for decreasing and one for increasing the set point value, one can replace the change by upward and downward push-buttons for changing through binary inputs,
- **switching SP on IN2** - change the set point value during the control between the SP and the value of the additional input (SP2 parameter must be set to SP2, the other binary input cannot have set the function **switching SP on SP2**).

7.4. Outputs

The controller has four outputs. Each of them can be configured as a control or an alarm output.

For the proportional control (with the exception of analog outputs), the pulse period is set additionally.

The pulse period is the time which goes by between successive switches of the output during the proportional control. The length of the pulse period must be chosen depending on dynamic object properties and suitably for the output device. For fast processes, it is recommended to use SSR relays. The relay output is used to steer contactors in slow-changing processes. The application of a high pulse period to steer fast-changing processes can give unwanted effects in the shape of oscillations. In theory, lowest the pulse period, better the control, but for a relay output it can be as large as possible in order to prolong the relay life.

Recommendations concerning the pulse period:

Table 3

Output	Pulse period	Load
Electromagnetic relay	Recommended >20 s, min. 10 s	2 A/230 V a.c.
	min. 5 s	1 A/230 V a.c.
Transistor output	1...3 s	SSR relay

8. CONTROL

8.1. ON-OFF Control

When a great accuracy of temperature control is not required, especially for objects with a great time constant and small delay, one can apply the on-off control with hysteresis.

Advantages of this way of control are simplicity and liability, but disadvantage is the appearance of oscillations, even at small hysteresis values.

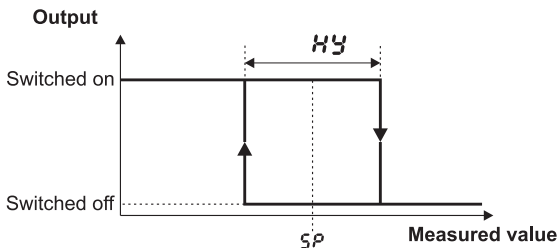

Fig. 16. Operation way of the heating output type

8.2. Innovative SMART PID algorithm

When a high accuracy of the temperature control is required, one must use the PID algorithm.

The applied innovative SMART PID algorithm is characterized by an increased accuracy for a wider class range of controlled objects. The controller tuning of the object consists on the manual setting of the proportional element value, integration element, differentiation element, or automatically – by means of the auto-tuning function.

8.2.1. Auto-tuning

The controller has the function to select PID settings. These settings ensure in most of case an optimal control.

To begin the auto-tuning, one must transit to the **Auto** (acc. to the fig. 13) and hold down the  push-button during at least 2 seconds. If the control algorithm is set on on-off or the auto-tuning function is locked, then the **Auto** message will be hidden.

For the correct execution of the auto-tuning function, the setting of **SetLo** and **SetHi** parameters is required. One must set the **SetLo** parameter on the value corresponding to the measured value at the switched off control. For object temperature control, one can set 0°C.

One must set the **SetHi** parameter on the value corresponding to the maximum measured value when the control is switched on the full power.

The flickering ST symbol informs about the activity of the auto-tuning function. The duration of auto-tuning depends on dynamic object properties and can last maximally 10 hours. In the middle of the auto-tuning or directly after it, over-regulations can occur, and for this reason, one must set a smaller set point, if it possible.



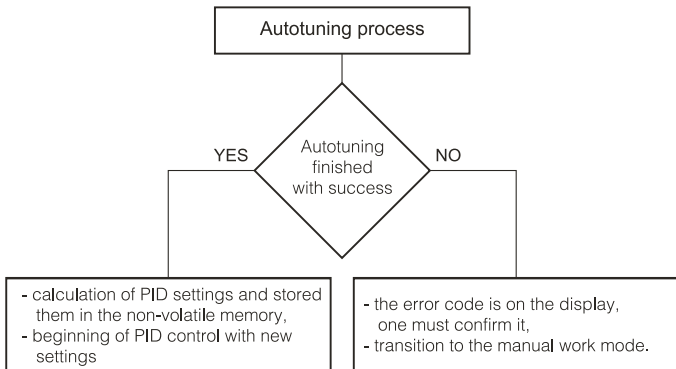





The auto-tuning is composed of following stages:

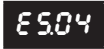

The auto-tuning process will be stopped without counting PID settings, if a supply decay occurs or the  push-button will be pressed. In this case, the control with current PID settings begins. If the auto-tuning is not achieved with success, the error code acc. to the table 4 will be displayed.

Error codes for auto-tuning

Table 4

Error code	Reason	How to proceed
	P or PD control was selected.	One must select PI, PID control, i.e. the TI element must be higher than zero.
	The set point value is incorrect.	One must change one or more set point value or <i>SetLo, SetHi</i> .
	The  push-button was pressed.	
	The maximal duration time of auto-tuning was exceeded.	Check if the temperature sensor is correctly placed and if the set point value is not set too higher for the given object.
	The waiting time for switching was exceeded.	
	The measuring input range was exceeded.	Pay attention for the sensor connection way. Do not allow that an over-regulation could cause the exceeding of the input measuring range.
	Very non-linear object, making impossible to obtain correct PID parameter values, or noises have occurred.	Carry out the auto-tuning again. If that does not help, select manually PID parameters.

8.2.2. Auto-tuning and “Gain Scheduling”

In case, when “Gain Scheduling” is used, one can carry out the auto-tuning in two ways.

The first way consist on choosing a suitable set of PID parameters, in which calculated PID parameters will be stored and realizing the auto-tuning on the level of the currently chosen set point value for the fixed set point control. One must set the $\zeta_{t\gamma}$ parameter on set, and choose Gset between $P, d\ 1$ and $P, d\ 4$.

The second way enables the automatic realization of the auto-tuning for all PID sets. One must set the $\zeta_{t\gamma}$ parameter on SP , and choose the number of PID sets for setting – parameter $\zeta_{5\alpha b}$. Set point values for individual PID sets must be give in $SP, SP2, SP3, SP4$ parameters, from the lowest to the highest.

8.2.3. Proceeding Way in Case of a Dissatisfying PID Control

The best way to select PID parameters is to change the value into a twice higher or into a twice lower. During changes, one must respect following principles:

a) Oscillations:

- increase the proportional band,
- increase the integration time,
- increase the differentiation time.

b) Over-regulations:

- increase the proportional band,

- increase the differentiation time,
- increase the integration time.

c) Instability:

- increase the proportional band,
- increase the differentiation time.

d) Free jump response:

- decrease the proportional band,
- decrease the integration time.

Run of controlled value	Algorithms of controller operations			
	P	PD	P	PID
	Pb↑	Pb↑ td↓	Pb↑	Pb↑ ti↑ td↓
	Pb↑	Pb↑ td↑	Pb↑ ti↑	Pb↑ ti↑ td↑
		Pb↓ td↓		Pb↓ td↓
	Pb↓	Pb↓	ti↓	Pb↓ ti↓

Fig. 17. Way to correct PID parameters.

8.3. Step-by-step control

The controller's step-by-step control algorithm without feedback was changed.

The description is provided below.

The controller offers two algorithms of the step-by-step control for cylinder control:

- with no feedback signal from the valve – opening and closing of the valve is based on PID parameters and control deviation,
- with a feedback signal from the valve positioning device – opening and closing of the valve is based on PID parameters, control deviation and valve position read from the additional input.

To select a step-by-step control, set one of the outputs $out\ 1...out\ 4$ to YOP and one of the outputs $out\ 1...out\ 4$ to YCL . For the algorithm with no feedback - the parameter Fdb should be set to no , for the algorithm with a feedback - the parameter Fdb should be set to YES . Additionally, set the insensitivity range for the set point, in which the valve does not change its position - the parameter Hn and select the set of PID parameters. Auto-tuning algorithm is not available for the step-by-step control.

Step-by-step control with no feedback additionally requires the parameters settings: valve open time t_{noo} , valve close time t_{noc} , minimum valve work time $n_{t.u}$.

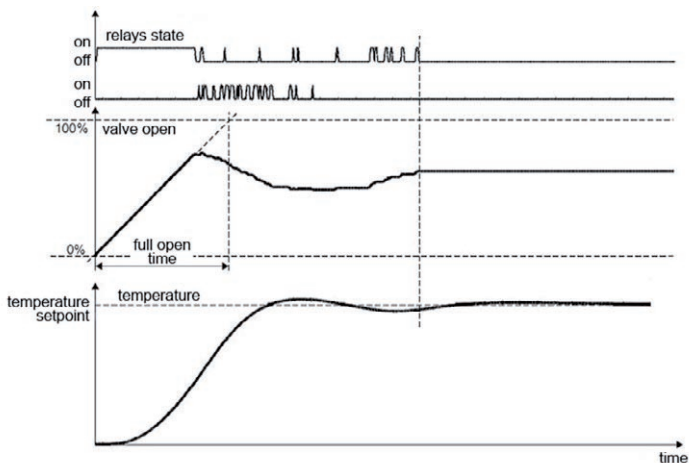

Fig. 18. Three-step step-by-step control with no feedback

The principle of the algorithm shown in Fig.18 is based on conversion of changing the control signal to the relay opening / closing time referred to the full opening / closing time.

The differences between the calculated and the actual valve position are unavoidable because of multiple changes in the direction of valve movement due to the inertia of a drive or its wear in the absence of a feedback. The controller uses the function of automatic positioning of a drive during operation to eliminate these differences. This function does not require user intervention and its function is to extend switching on time of the relay when the control signal reaches 0% or 100%.

The relay for opening / closing will remain on for a time equal to the time of a valve full open / close from a moment of a signal reaching 100% / 0%. The positioning of the valve will be stopped once the signal is equal to the maximum value.

In the specific case, the positioning is performed by completely closing the valve, it is carried out each time after:

- turning the controller supply on
- changing full open / close time.

The time of full opening of the valve can have a different value than the time of closing.

Both parameters should be set to the same value when using a drive with identical times.

8.4. "Gain Scheduling" Function

For control systems, Where the object behaves decidedly differently in various temperatures, it is recommended to use the "Gain Scheduling" function. The controller allows to remember up to four sets of PID parameters and switch them over automatically. The switching between PID sets runs percussiveless and with hysteresis, in order to eliminate oscillations on switching limits.

The CLY parameter settles the way of the function operation.

OFF	The function is disabled
SP	<p>a) Switching depending on the set point value. Additionally, one must also choose the number of PID sets - $CLNb$, parameter, and set their switching levels $CL12$, $CL23$, $CL34$.</p> <p>b) For the programmed control, one can set the PID set individually for each segment. Then for the given $Prnn$, program, in the $PEFC$ group, one must set the $Pi d$ parameter on on.</p>
SET	Permanently setting of one PID set. The PID set is set through the $CLSEt$ parameter.

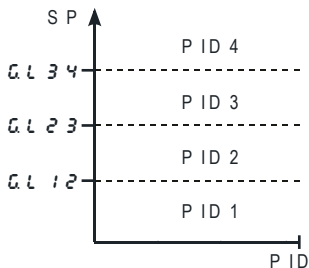

Fig 19. "Gain Scheduling" switched over from SP

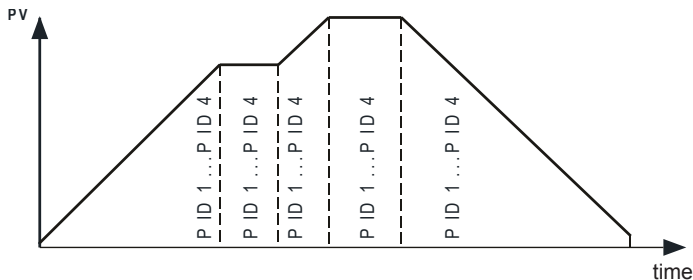

Fig. 20. "Gain Scheduling" switched over for each segment in the programmed control

8.5. Control of Heating-cooling Type

For the heating-cooling control, one of the outputs $out\ 1...out\ 4$ should be set to Y , one of the outputs $out\ 1...out\ 4$ should be set to $cool$ and the displacement zone Hn for cooling should be configured.

For the heating loop, the PID parameters should be configured: Pb, t, td , for the cooling loop the PID parameters: Pbc, tc, tdc . The parameter Pbc is defined as the ratio of the Pb parameter from the range 0.1...200.0 %.

The pulse period for logic outputs (relay, SSR) is set independently for the heating and cooling loops (depending on the output, these are $to\ 1...to\ 4$).

If there is the need to use the PID control in one loop and the ON-OFF control in the other loop, one output should be set to PID control and the other one upper relative alarm.

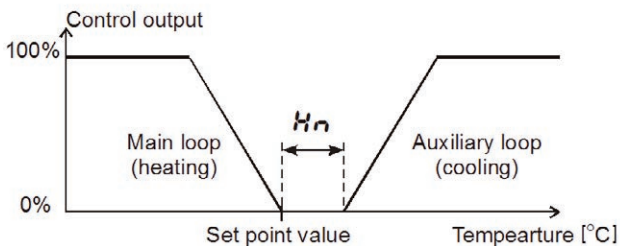
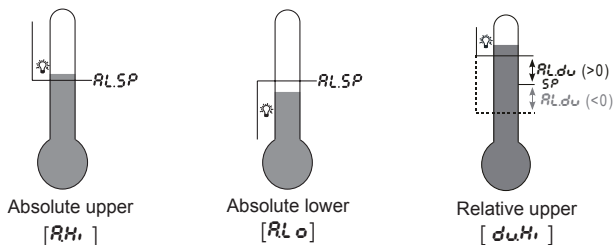

Fig.21. Control with two loops – heating-cooling type

9. ALARMS

Four alarms are available in the controller, which can be assigned: to each output. The alarm configuration requires the selection of the alarm kind through setting *out 1*, *out 2*, *out 3* and *out 4* parameters on the suitable type of alarm. Available types of alarms are given on the fig. 22.



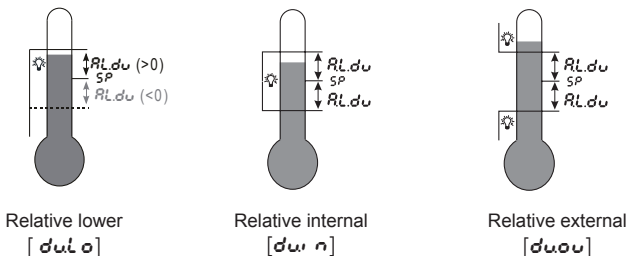



Fig. 22. Kinds of alarms

The set point value for absolute alarms is the value defined by the $Rx.SP$, parameter, and for relative alarms, it is the deviation from the set point value in the main loop - $Rx.du$ parameter. The alarm hysteresis, i.e. the zone around the set point value, in which the output state is not changed, is defined by the $Rx.HY$ parameter.

One can set the alarm latch, i.e. the memorizing of the alarm state after stopping alarm conditions (parameter $Rx.Lt = on$). The erasing of alarm memory can be made by the pressure of the  push-button in the normal working mode or interface.





10. TIMER FUNCTION

When reaching the set point temperature (SP) the timer begins the countdown of the time defined by the t_{nr} time parameter. After counting down to zero, the timer alarm is set, which remains active till the moment of the timer erasing.

To activate the timer function, one must set the parameter $t_{nr} = on$. To indicate the alarm state on an output, one of the outputs $out 1...out 3$ should be set to ALt .

The timer status/ remaining time is displayed with the mark „t” on the first position. To display it, one must press the  push-button till the moment of its appearance on the lower display (acc. to the fig. 13).

The return to the set point value display is set by the manufacturer on 30 sec, but can be changed, or disabled using the t_{out} parameter.

Status	Description	Signaling
timer stopped		t - - -
Starting of the timer	- temperature over SP - Press the  push-button	Remaining time in minutes: e.g. (t 299)
Pause of the timer	Press the  push-button	Flickering remaining time in minutes
End of the countdown	Reaching zero by the timer	t End
Timer erasing	During the countdown: Press  and  push-buttons	
	After the countdown end: - press the  push-button - through the binary input	

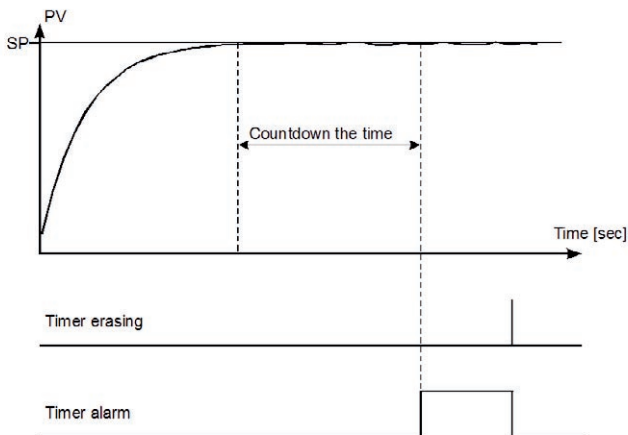



Fig.23. Principle of timer operation

11. CURRENT TRANSFORMER INPUT

After connecting the current transformer (CT-94-1 type), the measurement and display of the current flowing through the load steered by the output 1, is possible.

The first output must be of relay or voltage 0/5 V type. For the current counting, the minimal time of the output switching on must be at least 200 ms.

The transformer work range is equal 0 to 50 A. The heater current is displayed with the mark „R” in the first position.

In order to display the heater current, one must press the  push-button till the moment of its appearance on the lower display. The return to the set point value display is set by the manufacturer on 30 sec, but can be changed or disabled through the `εουε` parameter.

Two types of alarms concerning the heating element are available – the shorting alarm of the control element and the heater burnout alarm. The shorting alarm is realized by the current measurement when the control element is disabled, however the burnout alarm is realized when the control element is enabled.

The alarm configuration includes setting the alarm type. For the heater damage alarm `ουε2...ουε4=RL.kb`, and for the controlling element damage alarm `ουε2 ... ουε4=RL.oS`. Remaining parameters to set are the alarm set point value `hb.SP, oSSP` and the `hb.HY, oSHY` hysteresis.



For a correct detection of the heater alarm burnout, the heating element cannot be connected later than the controller.

12. ADDITIONAL FUNCTIONS



12.1. Control Signal Monitoring

The control signal of heating type is displayed with the mark „h” on the first position, of cooling type is displayed with the mark „c”, of valve opening is displayed with the mark „o”, and valve closing is displayed with the mark „c”. The access to the control signal depends on the suitable controller configuration. To display the control signal, one must press the  push-button till the moment of its appearance on the lower display (acc. to the fig. 13). The return to the set point value display is set by the manufacturer on 30 sec. but it can be changed, or disabled through the $\xi o u t$ parameter.

12.2. Manual Control

The input to the manual control mode follows after holding down the , push-button during the control signal display. The manual control is signaled by the pulsation of the LED diode. The controller interrupts the automatic control and begins the manual control of the output. The control signal value is on the lower display, preceded by the symbol „h” – for the main loop and „c” – for the auxiliary loop (cooling).

The  push-button serves to transit between loops (if the heating – cooling control mode is selected).

The  and  push-buttons serve to change the control signal. The exit to the normal working mode follows after the pressure of  push-button.

At set on-off control on the output 1 (parameter PB=0), one can set the control signal on 0% or 100% of the power, however when the PB parameter is higher than zero, one can set the control signal on any value from the range 0...100%.

12.3. Signal Retransmission

The continuous output can be used for the retransmission of selected value, e.g. in order to the temperature recording in the object or the set point value duplication in multi-zone furnaces.

The signal retransmission is possible if the output 1 or 2 is of continuous type. We begin the signal retransmission from setting the `out 1` or `out 2` parameter into `retr`. Additionally, one must set the upper and lower limit of the signal to be retransmitted (`Relo` and `Rahi`). The signal selection for retransmission is carried out through the `Rofn` parameter.

The recounting method of the retransmitted parameter into a suitable analog signal is shown on the fig. 24.

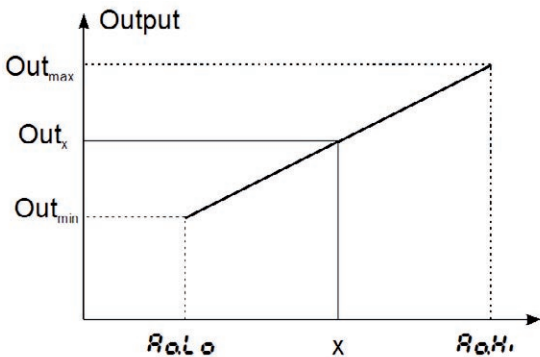

Fig. 24. Recounting of the signal for retransmission

The output signal is calculated acc. to the following formula.

$$out_x = out_{min} + (x - Ao.Lo) \frac{out_{max} - out_{min}}{Ao.Lo - Ao.Hi}$$

The **Ao.Lo** parameter can be set as higher than **Ao.Hi**, but the output signal will be then inversed.

12.4. Set Point Change Rate – Soft Start

The limitation of the temperature accretion rate is carried out through the gradually change of the set point value. This function is activated after the controller supply connection and during the change of the set point value. This function allows to reach softly from the actual temperature to the set point value. One must write the accretion value in the **SP.r**, parameter and the time unit in the **rRP** parameter. The accretion rate equals zero means that the soft start is disabled.

12.5. Digital Filter

In case when the measured value is instable, one can connect a programmed low-pass filter.

One must set the lowest time constant of the filter at which the measured value is stable. A high time constant can cause a control instability.

One can set the filter time constant **FLt** from 0.2 up to 100 seconds.

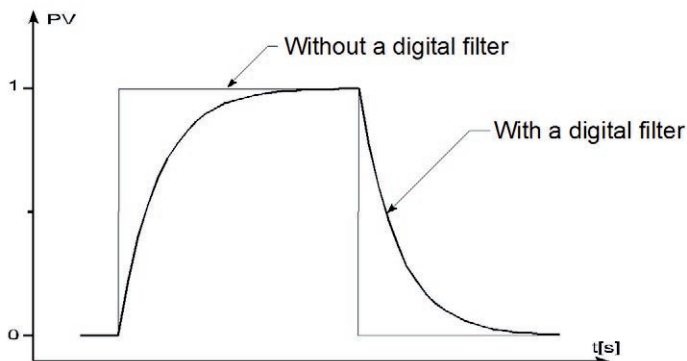



Fig. 25. Time characteristic of the filter

12.6. Manufacturer's Settings

Manufacturer's settings can be restored during the supply connection by holding down  and  push-buttons, till the moment when the *FABr* inscription appears on the higher display.

13. PROGRAMMING CONTROL

13.1. Description of Programming Control Parameters

List of configuration parameters

Table 5

<i>Prc</i> – Programming control					
<i>Prc 1</i>	Sub-menu of the program no 1				
:					
<i>Prc 15</i>	Sub-menu of the program no 15				
	<i>Pcfc</i>	Sub-menu of program parameters			
		Parameter symbol	Parameter description	Manufacturer's settings	Range of parameter change
					Sensors Linear input
		<i>Start</i>	Way to begin the program	<i>Pu</i>	<i>SP0</i> : from the way defined by <i>SP0</i> <i>Pu</i> : from the way defined by <i>SP0</i>
		<i>SP0</i>	Initial set point value	0.0 °C	MIN...MAX ¹⁾
		<i>time</i>	Unit for the segment duration time	<i>mnss</i>	<i>mnss</i> : minutes and seconds <i>HH.mn</i> : hours and minutes
		<i>accr</i>	Unit for the accretion rate of the set point value	<i>mn</i>	<i>mn</i> : minutes <i>Hour</i> : hours
		<i>hold</i>	Locking of the control deviation	<i>d15</i>	<i>d15</i> : inactive <i>L</i> : lower <i>H</i> : upper <i>brnd</i> : reversible

		ᲘᲑᲘᲗ	Number of program repetition	1	1...999	
		ᲑᲗᲗᲗ	Control after the supply decay	ᲘᲗᲗᲗ	ᲘᲗᲗᲗ : program continuation ᲑᲗᲗᲗ : control stoppage	
		ᲘᲗᲗ	Control on the program end	ᲑᲗᲗᲗ	ᲑᲗᲗᲗ : Control stoppage ᲗᲑᲗᲗ : fixed control with set point from the last segment	
		ᲑᲗᲗ	“Gain scheduling “ function for the program	ᲗᲑᲗᲗ	ᲗᲑᲗᲗ : disabled ᲗᲗᲗᲗ : enabled	
	ᲑᲗᲗᲗ	Submenu of program parameters				
	:	Submenu of program parameters				
	ᲑᲗᲗᲗ	Submenu of program parameters				
		Parameter symbol	Parameter description	Manufacturer's settings	Range of parameter change	
					sensors	linear input
		ᲗᲑᲗᲗ	Segment type	ᲗᲗᲗᲗ	ᲗᲗᲗᲗ : segment defined by the time ᲗᲗᲗᲗ : segment defined by the accretion ᲗᲗᲗᲗ : set point stoppage ᲘᲗᲗᲗ : program end	

	ε.5P	Set point on the segment end	0.0 °C	MIN...MAX ¹⁾	
	ε.ñE	Segment duration	00.01	00.01...99.59 ²⁾	
	ε.ε	Accretion rate of the set point	0.1	0.1...550.0 °C / time unit ⁴⁾ (0.1...990.0 °F / time unit ⁴⁾	1...5500 °C ³⁾ / time unit ⁴⁾ (1...9900 °F ³⁾ / time unit ⁴⁾
	ε.δ.δ	Value of the control deviation for which the counting of set point is interrupted	0.0	0.0...200.0 °C (0.0...360.0 °F)	0...2000 °C ³⁾ (0...3600 °F ³⁾)
	ε.υ.1	State of the auxiliary output no 1	oFF	oFF : disabled oOn : enabled	
	ε.υ.2	State of the auxiliary Output no 2	oFF	oFF : disabled oOn : enabled	
	ε.υ.3	State of the auxiliary Output no 3	oFF	oFF : disabled oOn : enabled	
	P.δ	PID set for the segment	P.δ.1	P.δ.1 : PID1 P.δ.2 : PID2 P.δ.3 : PID3 P.δ.4 : PID4	

1) See table 2.

2) The time unit is defined by the parameter **ε.ñ.υ**

3) The resolution to show the given parameter depends on the parameter **δP** – position of decimal point.

4) The time unit is defined by the parameter **ε.ε.υ**

13.2. Definition of Set Point Value Programs

One can define 15 programs. The maximal number of segments in the program is equal to 15.

To render visible parameters related to the programming control in the menu, the parameter SP_{nd} must be set on PRG . For each program, one must set parameters given in the submenu of program parameters. For each segment, one must select the kind of segment and next, parameters depending on the kind of segment acc. to the table 6. One must also set the output state (only when $out\ 1...out\ 4$ are set to $\epsilon_{u\ 1}, \epsilon_{u\ 2}, \epsilon_{u\ 3}$) – parameter $\epsilon_{u\ 1}, \epsilon_{u\ 2}, \epsilon_{u\ 3}$.

List of segment configuration parameters

Table 6

$\epsilon_{YPE} = \epsilon, \tilde{n}\epsilon$	$\epsilon_{YPE} = rR\epsilon\epsilon$	$\epsilon_{YPE} = d\epsilon\epsilon L$	$\epsilon_{YPE} = \epsilon_{nd}$
$\epsilon.SP$	$\epsilon.SP$	$\epsilon, \tilde{n}\epsilon$	
$\epsilon, \tilde{n}\epsilon$	rr		
$hLd\epsilon$	$hLd\epsilon$		

The fig. 26 and the table 7 represent an example of set point value program. It is assumed in the program that the temperature in the object has to increase from the initial temperature in the object up to 800°C, with the rate of 20°C per minute, at the active locking from the deviation.

Next, during 120 minutes, the temperature is maintained (locking disabled), after that, the temperature has to decrease to 50°C during 100 minutes (locking disabled). During the object cooling, one must turn on the fan connected to the auxiliary output no 2 (parameter $out\ 2$ set on $\epsilon_{u\ 1}$).

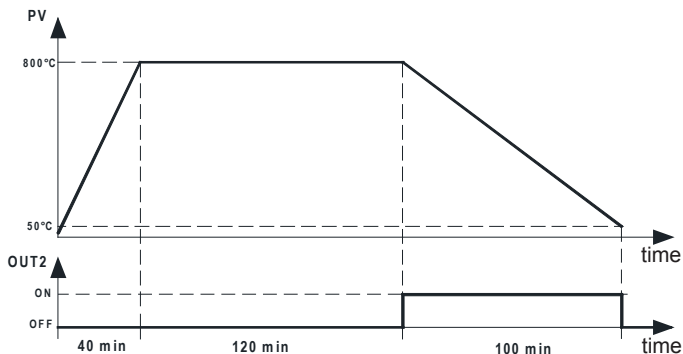

Fig. 26. Example of program

Parameter values for the example as above.



Table 7

	Parameter	Value	Meaning
P.C.F.G.	Start	P _U	Start to count the set point value from the current temperature
	t _{unit}	HH:nn	Time unit: hour, minute
	acc _{unit}	nn	Unit for the accretion rate: minute
	hold	band	Locking for the program: active – two-sided
	cycle _n	1	Number of program repetitions
	FR _{IL}	cont	Program continuation after a supply decay
	End	Stop	Control stoppage after the program end

St01	TYPE	rRE	Kind of segment: accretion rate
	tSP	800.0	Target set point value: 800.0 °C
	rr	20.0	Accretion rate 20.0 °C / minute
	hLdu	50.0	Active locking, when the deviation exceeds 50.0 °C
	Ev1	OFF	Output 2 as the auxiliary output Ev1: disabled
St02	TYPE	duEL	Kind of segment: stoppage of set point value
	t, nE	02.00	Segment time 2h00 = 120 minutes
	Ev1	OFF	Output 2 as the auxiliary output Ev1 – disabled
St03	TYPE	t, nE	Kind of segment: accretion time
	tSP	50.0	Target set point value: 50.0 °C
	t, nE	01.40	Segment time 1h40 = 100 minutes
	hLdu	0.0	Inactive locking
	Ev1	on	Output 2 as the auxiliary output Ev1: enabled
St04	TYPE	End	Kind of segment: program end
	Ev1	OFF	Output 2 as the auxiliary output Ev1: disabled

13.3. Control of the Set Point Value Program

When the *S.P.n* parameter is set on *P.r.G*, the controller controls the object in compliance with the set point value changing in time acc. to the given program. Before starting the control with the changeable set point value, one must select the required program (parameter *L.P.r.G*).

To start the program, one must press  and , push-buttons when the *Stop* inscription appears on the lower display (fig. 27).

The lighted dot in the right corner of the lower display, means that the programming control is lasting. During the program duration, one can display parameters of the realized program, i.e. program status, program number, number of the operating segment, the number of cycles which still remains to carry out, time which goes by in the segment, time which remained to the end of the segment, time which remained to the program end.

After finishing the program the dot is gone out, or the program is renewed, if the number of the program repetition *L.Y.L.n* is higher than 1.

After finishing the control, auxiliary outputs are in the state defined by parameters – output state for the segment set as the program end.

When the parameter *hold* (locking in the program) is set on *L.o*, *H*, or *b.R.n* and the locking value *h.l.d.u* in the operating segment is higher than zero then, the size of the control deviation is controlled (set point value minus measured value). For *hold=L.o* the locking is active, when the measured value is below the set point value diminished by the locking value. For *hold=H*, the locking is active, when the measured value exceeds the set point value by the locking value. For *hold=b.R.n* the locking is active, as for the upper and lower locking. If the locking is active then, the counting of the set point value is interrupted, and the dot in the right corner is flickering. The controller controls acc. to the last calculated set point value.

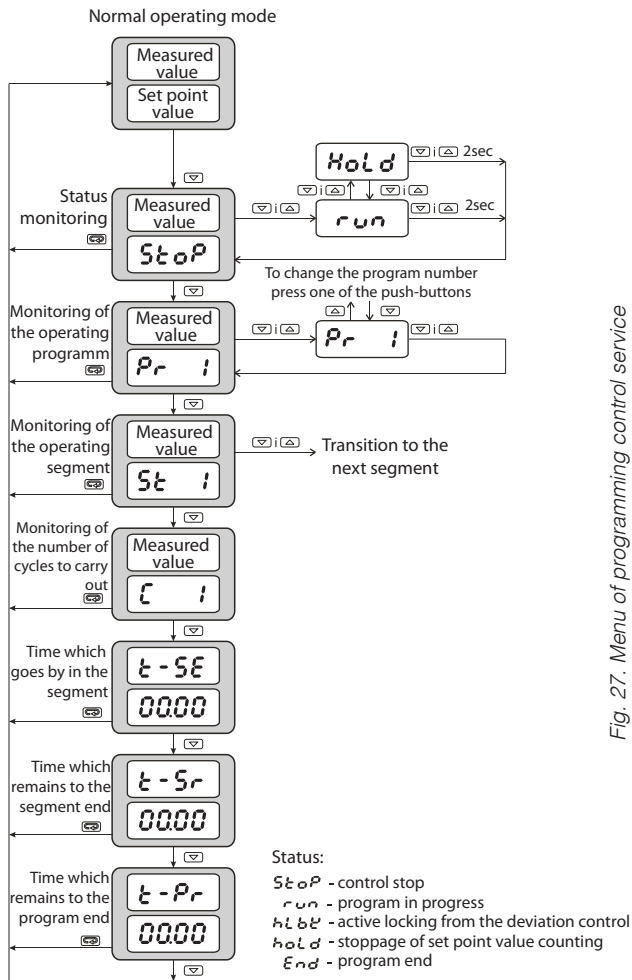

Fig. 27. Menu of programming control service

14. RS-485 INTERFACE WITH MODBUS PROTOCOL

14.1. Introduction

The VC-88 controller is equipped with a serial interface in RS-485 standard, with implemented asynchronous communication protocol MODBUS.

The list of serial interface parameters for the VC-88 controller:

- device address: 1..247,
- baud rate: 4800, 9600, 19200, 38400, 57600 bit/s,
- operating mode: RTU,
- information unit: 8N2, 8E1, 8O1, 8N1,
- data format: integer (16 bit), float (32 bit),
float (2x16 bit),
- maximal response time: 500 ms,
- maximal number of registers
read out/ written by a single
Modbus frame: 116.

The VC-88 controller realizes following protocol functions:

Table 8

Code	Meaning
03	read out of n-registers
06	write of 1 register
16	write of n-registers
17	identification of the slave device

14.2. Error Codes

If the controller receives a request with a transmission or checksum error, the request will be ignored. For a request synthetically correct but with incorrect values, the controller will send an answer including the error code.

Possible error codes and their meanings are presented in the table 9.

Error codes

Table 9

Code	Meaning	Reason
01	forbidden function	The function is not serviced by the controller.
02	forbidden data address	The register address is beyond the range.
03	forbidden data value	The register value is beyond the range or the register is only to readout.

14.3. Register Map

Map of register groups

Table 10

Range of addresses	Type of values	Description
4000 – 4149	Integer (16 bits)	The value is situated in a 16-bit register
4150 – 5899	Integer (16 bits)	The value is situated in a 16-bit register
7000 – 7099	float (2x16 bits)	The value is situated in two successive 16-bit registers; Registers only for readout
7500 – 7599	float (32 bits)	The value is situated in two successive 32-bit registers; Registers only for readout

In the controller, data are situated in 16-bit registers. The list of registers for write and readout is presented in the table 11.

Operation „R-” – means the possibility of readout, and the operation „RW” means the possibility for readout and write.

Map of register from address 4000

Table 11

Register address	Marking	Operation	Parameter range	Description
4000		-W	1...6	Register of commands: 1 – input into the automatic control mode 2 – input into the manual control mode 3 – beginning of the auto-tuning 4 – erasing of alarm memory 5 – restoration of manufacturer's settings (apart interface settings and defined programs) 6 – restoration of manufacturer's settings of defined programs.
4001		R-	100...999	Number of program version [x100]
4002		R-		Version code of the controller bit 2 1 0 – OUTPUT 1: 0 0 1 – output 1 – relay 0 1 0 – output 1 – 0/5 V 0 1 1 – output 1 – continuous current : 0/4...20 mA 1 0 0 – output 1 – continuous voltage: 0...10 V bit 5 4 3 – OUTPUT 2: 0 0 1 – output 2 – relay 0 1 0 – output 2 – 0/5 V 0 1 1 – output 2 – continuous current: 0/4...20 mA 1 0 0 – output 2 – continuous voltage: 0...10 V

4003		R-	0...0xFFFF	Controller status – description in table 12
4004		R-	0...0xFFFF	Alarm state – description in table 13
4005		R-	0...0xFFFF	Error status – Description in table 14
4006		R-	acc. to table 17 ¹⁾	Measured value PV
4007		R-	-1999...9999	Measured value on additional input
4008		R-	acc. to table 17 ¹⁾	Current set point value SP
4009		RW	0...1000	Control signal of loop 1 [% x10] ²⁾
4010		RW	0...1000	Control signal of loop 2 [% x10] ²⁾
4011		R-	0...59994	Timer value [s]
4012		R-	0...500	Heater current when the output is turned on [A x10]
4013		R-	0...500	Heater current when the output is turned off [A x10]
4014	UNIT	RW	0...2	Unit: 0 – Celsius degrees 1 – Fahrenheit degrees 2 – physical units
4015	INPT	RW	0...14	Kind of main input: 0 – resistance thermometer Pt100 1 – resistance thermometer Pt1000 2 – thermocouple of J type 3 – thermocouple of T type 4 – thermocouple of K type 5 – thermocouple of S type 6 – thermocouple of R type 7 – thermocouple of B type 8 – thermocouple of E type 9 – thermocouple on N type 10 – thermocouple of L type 11 – current input: 0-20mA 12 – current input: 4-20mA 13 – voltage input: 0-5 V 14 – voltage input: 0-10 V

4016	DP	RW	0...1 ^{3) 4)} 0...2 ⁵⁾	Position of the decimal point of the main input: 0 – without decimal place 1 – 1 decimal place 2 – 2 decimal places
4017	INLO	RW	-999...9999 ¹⁾	Indication for the lower threshold of the analog main input.
4018	INHI	RW	-999...9999 ¹⁾	Indication for the upper threshold of the analog main input.
4019	SHIF	RW	-999...999 ¹⁾	Shift of the measured value of the main input.
4020	I2TY	RW	0...1	Kind of the additional input: 0 – current input: 0-20mA 1 – current input: 4-20mA
4021	DP2	RW	0...2	Position of the decimal point of the additional input: 0 – without a decimal place 1 – 1 decimal place 2 – 2 decimal places
4022	I2LO	RW	-999...9999 ¹⁾	Indication for the lower threshold of the analog main input.
4023	I2HI	RW	-999...9999 ¹⁾	Indication for the upper threshold of the analog main input.
4024	FILT	RW	0...9	Time constant of the filter: 0 – OFF 1 – 0.2 sec 2 – 0.5 sec 3 – 1 sec 4 – 2 sec 5 – 5 sec 6 – 10 sec 7 – 20 sec 8 – 50 sec 9 – 100 sec

4025	BNI1	RW	0...10	<p>Function of the binary input 1</p> <ul style="list-style-type: none"> 0 – none 1 – control stop 2 – switching on manual control 3 – SP1 switching into SP2 4 – erasing of the timer alarm 5 – program start 6 – jump to the next segment 7 – stoppage of set point value counting in the program 8 – decrease of the set point value 9 – increase of the set point value 10 – switching SP on the additional input value
4026	BNI2	RW	0...10	<p>Function of the binary input 2</p> <ul style="list-style-type: none"> 0 – none 1 – control stop 2 – switching on manual control 3 – SP1 switching into SP2 4 – erasing of the timer alarm 5 – program start 6 – jump to the next segment 7 – stoppage of set point value counting in the program 8 – decrease of the set point value 9 – increase of the set point value 10 – switching SP on the additional input value
4027	OUT1	RW	0...14	<p>Function of output 1:</p> <ul style="list-style-type: none"> 0 – without function 1 – control signal 2 – control signal of stepper control – opening ⁷⁾ 3 – control signal of stepper control – closing ⁷⁾ 4 – control signal - cooling 5 – absolute upper alarm 6 – absolute lower alarm 7 – relative upper alarm 8 – relative lower alarm 9 – relative internal alarm

				<ul style="list-style-type: none"> 10 – relative external alarm 11 – timer alarm 12 – retransmission 8) 13 – auxiliary output EV1 in the programming control 14 – auxiliary output EV2 in the programming control 15 – auxiliary output EV3 in the programming control
4028	O1TY	R	1...6	Output 1 type: 1 – relay output 2 – voltage output: 0/5 V 3 – current output : 4-20 mA 4 – current output : 0-20 mA 5 – reserved 6 – voltage output:: 0-10 V
		RW	3...4 ⁶⁾	
4029	YFL	RW	0...1000	Control signal of output 1 for proportional control in case of sensor damage [% x10]
4030	OUT2	RW	0...17	Function of output 2: 0 – without function 1 – control signal 2 – control signal of stepper control – opening ⁷⁾ 3 – control signal of stepper control – closing ⁷⁾ 4 – control signal - cooling 5 – absolute upper alarm 6 – absolute lower alarm 7 – relative upper alarm 8 – relative lower alarm 9 – relative internal alarm 10 – relative external alarm 11 – timer alarm 12 – alarm of heater burnout 13 – controlling element damage alarm (short - circuit) 14 – retransmission8) 15 – auxiliary output EV1 in the programming control 16 – auxiliary output EV2 in the programming control 17 – auxiliary output EV3 in the programming control

4031	O2TY	R	0...6	Output 2 type: 0 – without relay 1 – relay soutput 2 – voltage output: 0/5 V 3 – current output : 4-20 mA 4 – current output : 0-20 mA 5 – voltage output: 0-5 V 6 – voltage output:: 0-10 V
		RW	3...4 ⁶⁾	
4032	OUT3	RW	0...16	Function of output 3: 0 – without function 1 – control signal 2 – control signal of stepper control – opening ⁷⁾ 3 – control signal of stepper control – closing ⁷⁾ 4 – control signal - cooling 5 – absolute upper alarm 6 – absolute lower alarm 7 – relative upper alarm 8 – relative lower alarm 9 – relative internal alarm 10 – relative external alarm 11 – timer alarm 12 – alarm of heater burnout 13 – controlling element damage alarm (short- circuit) 14 – auxiliary output EV1 in the programming control 15 – auxiliary output EV2 in the programming control 16 – auxiliary output EV3 in the programming control
4033	OUT4	RW	0...16	Function of output 4: 0 – without function 1 – control signal 2 – control signal of stepper control – opening ⁷⁾ 3 – control signal of stepper control – closing ⁷⁾ 4 – control signal - cooling 5 – absolute upper alarm 6 – absolute lower alarm 7 – relative upper alarm 8 – relative lower alarm 9 – relative internal alarm 10 – relative external alarm 11 – timer alarm

				<p>12 – alarm of heater burnout</p> <p>13 – controlling element damage alarm (short - circuit)</p> <p>14 – auxiliary output EV1 in the programming control</p> <p>15 – auxiliary output EV2 in the programming control</p> <p>16 – auxiliary output EV3 in the programming control</p>
4034	ALG	RW	0...1	Control algorithm: 0 – on-off 1 – PID
4035	TYPE	RW	0...1	Kind of control: 0 – direct control – cooling 1 – reverse control – heating
4036	HY	RW	2...999 ¹⁾	Hysteresis HY
4037	GTY	RW	0...2	“Gain Scheduling “ function 0 – disabled 1 – from set point value 2 – constant PID set
4038	GSNB	RW	0...2	Number of PID sets for “Gain Scheduling” from the set point value. 0 – 2 PID sets 1 – 3 PID sets 2 – 4 PID sets
4039	GL12	RW	acc. to table 17 ¹⁾	Switching level for PID1 and PID2 sets
4040	GL23	RW	acc. to table 17 ¹⁾	Switching level for PID2 and PID3 sets
4041	GL34	RW	acc. to table 17 ¹⁾	Switching level for PID3 and PID4 sets
4042	GSET	RW	0...3	Selection of the constant PID set 0 – PID1 1 – PID2 2 – PID3 3 – PID4

4043	PB	RW	0...9999 ¹⁾	Proportional band PB
4044	TI	RW	0...9999	Integration time constant TI [s]
4045	TD	RW	0...9999	Differentiation time constant TD [s x10]
4046	Y0	RW	0...1000	Correction of control signal (for P or PD control) [% x10]
4047	PB2	RW	0...9999 ¹⁾	Proportional band PB2
4048	TI2	RW	0...9999	Integration time constant TI2 [s]
4049	TD2	RW	0...9999	Differentiation time constant TD2 [s x10]
4050	Y02	RW	0...1000	Correction of control signal (for P or PD control) [% x10]
4051	PB3	RW	0...9999 ¹⁾	Proportional band PB3
4052	TI3	RW	0...9999	Integration time constant TI3 [s]
4053	TD3	RW	0...9999	Differentiation time constant TD3 [s x10]
4054	Y03	RW	0...1000	Correction of control signal (for P or PD control) [% x10]
4055	PB4	RW	0...9999 ¹⁾	Proportional band PB4
4056	TI4	RW	0...9999	Integration time constant TI4 [s]
4057	TD4	RW	0...9999	Differentiation time constant TD4 [s x10]
4058	Y04	RW	0...1000	Correction of control signal (for P or PD control) [% x10]
4059	TO1	RW	5...999	Pulse period of output 1 [s x10]
4060	HN	RW	0...999 ¹⁾	Displacement zone for heating-cooling control or dead zone for stepper control
4061	PBC	RW	1...2000	Proportional band PBC [% x10] (in relation to PB)
4062	TIC	RW	0...9999	Integration time constant TIC [s]
4063	TDC	RW	0...9999	Differentiation time constant TDC [s]

4064	TO2	RW	5...999	Pulse period of output 2 [s x10]
4065	A1SP	RW	acc. to table 17 ¹⁾	Set point value for absolute alarm 1
4066	A1DV	RW	-1999...1999 ¹⁾	Deviation from the set point value for relative alarm 1
4067	A1HY	RW	2...999 ¹⁾	Hysteresis for alarm 1
4068	A1LT	RW	0...1	Memory of alarm 1 0 – disabled 1 – enabled
4069	A2SP	RW	acc. to table 17 ¹⁾	Set point value for absolute alarm 2
4070	A2DV	RW	-1999...1999 ¹⁾	Deviation from the set point value for relative alarm 2
4071	A2HY	RW	2...999 ¹⁾	Hysteresis for alarm 2
4072	A2LT	RW	0...1	Memory of alarm 2 0 – disabled 1 – enabled
4073	A3SP	RW	acc. to table 17 ¹⁾	Set point value for absolute alarm 3
4074	A3DV	RW	-1999...1999 ¹⁾	Deviation from the set point value for relative alarm 3
4075	A3HY	RW	2...999 ¹⁾	Hysteresis for alarm 3
4076	A3LT	RW	0...1	Memory of alarm 3 0 – disabled 1 – enabled
4077	A4SP	RW	acc. to table 17 ¹⁾	Set point value for absolute alarm 4
4078	A4DV	RW	-1999...1999 ¹⁾	Deviation from the set point value for relative alarm 4
4079	A4HY	RW	2...999 ¹⁾	Hysteresis for alarm 4
4080	A4LT	RW	0...1	Memory of alarm 4 0 – disabled 1 – enabled

4081	HBSP	RW	0...500	Set point value for the heater damage alarm [Ax10]
4082	HBHY	RW	0...500	Hysteresis for the heater damage alarm [Ax10]
4083	SPMD	RW	0...5	Kind of set point value: 0 – set point value SP or SP2 1 – set point value with soft start in units per minute 2 – set point value with soft start in units per hour 3 – set point value from the additional input 4 – Set point value acc. to the programming control 5 – set point value SP or from the additional input
4084	SP	RW	acc. to table 17 ¹⁾	Set point value SP
4085	SP2	RW	acc. to table 17 ¹⁾	Set point value SP2
4086	SP3	RW	acc. to table 17 ¹⁾	Set point value SP3
4087	SP4	RW	acc. to table 17 ¹⁾	Set point value SP4
4088	SPLL	RW	acc. to table 17 ¹⁾	Lower limitation of the fast set point value change
4089	SPLH	RW	acc. to table 17 ¹⁾	Upper limitation of the fast set point value change
4090	SPRR	R	0...9999 ¹⁾	Accretion rate of the set point value SP1 or SP2 during the soft start
4091	ADDR	RW	1...247	Device address
4092	BAUD	RW	0...4	Baud rate: 0 – 4800 1 – 9600 2 – 19200 3 – 38400 4 – 57600

4093	PROT	RW	0...4	Protocol: 0 – none 1 – RTU 8N2 2 – RTU 8E1 3 – RTU 8O1 4 – RTU 8N1
4094	-	RW	0...65535	Reserved
4095	AOFN	RW	0...5	Quantity retransmitted on the main input: 0 – measured value on the main input PV 1 – measured value on the additional input PV2 2 – measured value PV – PV2 3 – measured value PV2 – PV 4 – set point value 5 – deviation (set point value – measured value PV)
4096	AOLO	RW	acc. to table 17 ¹⁾	Lower limit of signal for retransmission
4097	AOHI	RW	acc. to table 17 ¹⁾	Upper limit of signal for retransmission
4098	SECU	RW	0...9999	Access code to the menu
4099	STFN	RW	0...1	Auto-tuning function: 0 – locked 1 – unlocked
4100	STLO	RW	acc. to table 17 ¹⁾	Lower limit of signal for retransmission
4101	STHI	RW	acc. to table 17 ¹⁾	Upper limit of signal for retransmission
4102	TOUT	RW	0...250	Time of automatic output from the monitoring mode
4103	TIMR	RW	0...1	Timer function: 0 – disabled 1 – enabled
4104	TIME	RW	1...9999	Time counted down by the timer [min x 10]
4105	DI2	RW	0...1	Monitoring of the auxiliary input: 0 – disabled 1 – enabled

4106	DCT	RW	0...1	Monitoring of heater current: 0 – disabled 1 – enabled
4107	BAR1	RW	0...6	Function of the upper bargraph: 0 – measured value on the main input PV 1 – measured value on the additional input PV2 2 – set point value 3 – control signal on the output 1 4 – control signal on the output 2 5 – segment time 6 – program time
4108	BAR2	RW	0...6	Function of the upper bargraph: 0 – measured value on the main input PV 1 – measured value on the additional input PV2 2 – set point value 3 – control signal on the output 1 4 – control signal on the output 2 5 – segment time 6 – program time
4109	BARL	RW	acc. to table 17 ¹⁾	Lower threshold for bargraphs
4110	BARH	RW	acc. to table 17 ¹⁾	Upper threshold for bargraphs
4111	TO3	RW	5...999	Pulse period of output 3 [s x10]
4112	TO4	RW	5...999	Pulse period of output 4 [s x10]
4113	FDB	RW	0...1	Algorithm for stepper control 0 – without feedback 1 – with feedback
4114	OSSP	RW	0...500	Set point for the controlling element damage alarm (short-circuit) [Ax10]
4115	OSHY	RW	0...500	Hysteresis for the controlling element damage alarm (short-circuit) [Ax10]
4116	TMVO	RW	30...6000	Valve open time [s x10]
4117	TMVC	RW	30...6000	Valve close time [s x10]

4118	MNTV	RW	1...999	Minimum valve work time [s x10]
4119	YLO	RW	0...1000	Minimum control signal [% x10]
4120	YHI	RW	0...1000	Maximum control signal [% x10]

1) Value with the decimal point position defined by bits 0 and 1 in the register 4003.

2) Parameter to write only in the manual operating mode

3) Concerns resistance thermometer inputs

4) Concerns thermocouple inputs

5) Concerns linear inputs

6) Range to write for continuous current outputs

7) Concerns output 1 of binary type

8) Concerns output 1 of continuous type.

Register 4003 – controller status

Table 12

bit	Description
0-1	Decimal point position for MODBUS registers from address 4000, depending on the input (0...2) ¹⁾
2-3	Decimal point position for MODBUS registers from address 4000, depending on the additional input (0...2) ¹⁾
4	Auto-tuning finished with failure
5	Soft start: 1 – active, 0 – inactive
6	Timer status: 1 – countdown finished, 0 – remaining states
7	Automatic control/manual: 0 – auto, 1 – manual
8	Auto-tuning: 1 – active, 0 – inactive
9-10	Current set of PID parameters 0 – PID1, 1 – PID2, 3 – PID3, 4 – PID4
11-12	Reserved
13	Measured value beyond the measuring range

14	Measured value on the additional input beyond the measuring input
15	Controller error – check the error register

1) For sensor inputs value equal 1, for linear inputs the value is depended on the parameter dp (register 4023)

Register 4004 – alarm state

Table 13

Bit	Description
0	State of alarm 1.:1 – active, 0 – inactive
1	State of alarm 2.:1 – active, 0 – inactive
2	State of alarm 3.:1 – active, 0 – inactive
3	State of alarm 4.:1 – active, 0 – inactive
4	Alarm state of heater burnout
5	Alarm state of permanent output 1 shorting:1 – active , 0 – inactive
6-15	Reserved

Register 4005 – error register

Table 14

Bit	Description
0	Discalibrated input
1	Discalibrated additional input
2	Discalibrated analog output 1
3	Discalibrated analog output 2
4-14	Reserved
15	Checksum error of controller memory

Register address	Marking	Operation	Parameter range	Description
4150		RW	0...14	Program number for realization (0 – means first program)
4151		RW	0...1	Program start/stop: 0 – program stop 1 – program start (the write causes the program start from the beginning)
4152		RW	0...1	Stoppage of set point value counting in the program: 0 – disabled 1 – enabled
4153		RW	0...14	Realized segment (0 – means the first program) The write causes the jump to the given segment.
4154		R-		Control status: 0 – control stop 1 – program in progress 2 – active locking from the control deviation 3 – Stoppage of set point value counting (by the push-button, binary input or interface) 4 – program end
4155		R-		Number of cycles which remains to the end
4156		R-		Time which goes out in the segment LSB [s]
4157		R-		Time which goes out in the segment MSB [s]
4158		R-		Time to the segment end LSB [s]

4159		R-		Time to the segment end MSB [s]		
4160		R-		Time to the segment end LSB [s]		
4161		R-		Time to the segment end MSB [s]		
4162		RW	0...65535	Reserved		
4163		RW	0...65535	Reserved		
4164		RW	0...65535	Reserved		
4165		RW	0...65535	Reserved		
4166		RW	0...65535	Reserved		
4167		RW	0...65535	Reserved		
4168		RW	0...65535	Reserved		
4169		RW	0...65535	Reserved		
4170	Program 1	Program parameters	STRT	RW	0...1	Way to begin the program: 0 – from value defined by SP0 1 – from current measured value
4171			SP0	RW	acc. to table 17 ¹⁾	Initial set point value
4172			TMUN	RW	0...1	Unit for the segment duration: 0 – minutes and seconds 1 – hours and minutes
4173			RRUN	RW	0...1	Unit for the accretion rate of the set point value: 0 – minutes 1 – hours
4174			HOLD	RW	0...3	Lockings of control deviations 0 – inactive 1 – lower 2 – upper 3 – two-sided
4175			CYCN	RW	1...999	Number of program repetitions
4176			FAIL	RW	0...1	Control after a supply decay: 0 – program continuation 1 – control stoppage

4177	Segment 1	END	RW	0...1	Control on the program end: 0 – control stoppage 1 – fixed control with the set point value of the last segment
4178		PID	RW	0...1	“Gain Scheduling “ function for the program: 0 – disabled 1 – enabled
4179		TYPE	RW	0...3	Kind of segment: 0 – segment defined by the time 1 – segment defined by the accretion 2 – stoppage of the set point value 3 – program end
4180		TSP	RW	acc. to table 17 ¹⁾	Set point value on the segment end
4181		TIME	RW	1...5999	Segment duration
4182		RR	RW	1...5500 ¹⁾	Accretion rate of the set point
4183		HLDV	RW	0...2000 ¹⁾	Value of the control deviation, over which the set point value counting is interrupted
4184			RW	0...7	State of auxiliary outputs (sum of bits): bit 0 is set – auxiliary output EV1 is turned on bit 1 is set – auxiliary output EV2 is turned on bit 2 is set – auxiliary output EV3 is turned on
4185		PID	RW	0...3	PID set for the segment: 0 – PID1 1 – PID2 2 – PID3 3 – PID4
...					...

4277	Segment 15	TYPE	RW	0...3	Kind of segment	
4278		TSP	RW	wg tablicy 17 ¹⁾	Set point value on the segment end	
4279		TIME	RW	0...5999	Segment duration	
4280		RR	RW	1...5500 ¹⁾	Accretion rate of the set point value	
4281		HLDV	RW	0...2000 ¹⁾	Control deviation value, over which the set point value counting is interrupted	
4282			RW	0...3	State of auxiliary outputs	
4283		PID	RW	0...3	PID set for the segment	
...						
5766	Program 15	Program parameters	STRT	RW	0...1	Way of program beginning
5767			SP0	RW	acc. to table 17 ¹⁾	Initial set point value
5768			TMUN	RW	0...1	Unit for the segment duration
5769			RRUN	RW	0...1	Unit for the accretion rate of the set point value
5770			HOLD	RW	0...3	Blockings of the control deviation
5771			CYCN	RW	1...999	Number of program repetitions
5772			FAIL	RW	0...1	Way of the controller behaviour after a supply decay.
5773			END	RW	0...1	Way of the controller behaviour on the program end
5774			PID	RW	0...1	"Gain Scheduling " function for the program
5775			Segment 1	TYPE	RW	0...3
5776	TSP	RW		acc. to table 17 ¹⁾	Set point value on the segment end	
5777	TIME	RW		0...5999	Segment duration	
5778	RR	RW		1...5500 ¹⁾	Accretion rate of the set point value	

5779	Segment 15	HLDV	RW	0...2000 ¹⁾	Control deviation value, over which the counting of the set point value is interrupted
5780			RW	0...7	State of auxiliary outputs
5781		PID	RW	0...3	PID set for the segment
...		...			
5873		TYPE	RW	0...3	Kind of segment
5874		TSP	RW	acc. to table 17 ¹⁾	Set point value on the segment end
5875		TIME	RW	0...5999	Segment duration
5876		RR	RW	1...5500 ¹⁾	Accretion rate of the set point value
5877 RW		HLDV	RW	0...2000 ¹⁾	Control deviation value, over which the counting of the set point value is interrupted
5878			RW	0...7	State of auxiliary outputs
5879	PID	RW	0...3	PID set for the segment	

¹⁾ Value with the decimal point position defined by bits 0 and 1 in the register 4002

Map of registers from address 7000 and 7500

Table 16

Register address	Register address	Symbol	Operatione	Description
7000	7500		R-	Measured value PV
7002	7501		R-	Measured value on the additional input
7003	7502		R-	Current set point value SP
7006	7503		R-	Control signal of loop 1

7008	7504		R-	Control signal of loop 2
7010	7505	SP	R-	Set point value SP
7012	7506	SP2	R-	Set point value SP2
7014	7507	A1SP	R-	Set point value for the absolute alarm
7016	7508	A1DV	R-	Deviation from the set point value for the relative alarm 1
7018	7509	A2SP	R-	Set point value for the absolute alarm
7020	7510	A2DV	R-	Deviation from the set point value for the relative alarm 2
7022	7511	A3SP	R-	Set point value for the absolute alarm 3
7024	7512	A3DV	R-	Deviation from the set point value for the relative alarm 3
7026	7513	A4SP	R-	Set point value for the absolute alarm 4
7028	7514	A4DV	R-	Deviation from the set point value for the relative alarm 4

Input ranges

Table 17

Kind of sensors	Range		
	UNIT = °C [x10]	UNIT = °F [x10]	UNIT = PU
Pt100	-2000...8500	-3280...15620	
Pt1000	-2000...8500	-3280...15620	
Fe-CuNi (J)	-1000...12000	-1480...21920	
Cu-CuNi (T)	-1000...4000	-1480...7520	

NiCr-NiAl (K)	-1000...13720	-1480...25016	
PtRh10-Pt (S)	0...17670	320...32126	
PtRh13-Pt (R)	0...17670	320...32126	
PtRh30-PtRh6 (B)	0...17670	320...32126	
NiCr-CuNi (E)	-1000...10000	-1480...18320	
NiCrSi-NiSi (N)	-1000...13000	-1480...23720	
chromel – kopel (L)	-1000...8000	-1480...14720	
Linear current (I)			-1999...9999
Linear current (I)			-1999...9999
Linear voltage (U)			-1999...9999
Linear voltage (U)			-1999...9999

15. SOFTWARE UPDATING

Function enabling updating of software from the computer of the PC with software LPCon was implemented in controller VC-88 (from version of software 2.00). The connected to the computer convertor RS485 is required on USB to the updating, e.g.: the convertor PD10.

a)

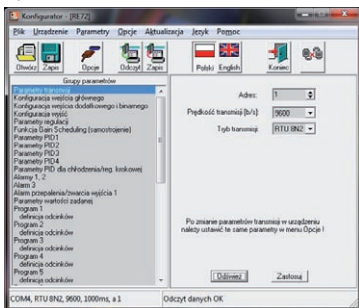

b)



Fig.28. Program view: a) LPCon, b) updating of software

Warning! Before doing update, currently settings of controller should be saved by program LPCon, because when software is updated default settings of controller are restored.

After starting LPCon's software COM port, baudrate, transmission mode and adress should be set. It can be done in *Options*. Then, RE82 controller should be selected from *Device*. Push icon *Load* to read and save current settings. Open window *Lumel Updater* (LU) – figure 28b from *Updating->Updating of devices firmware*. Push *Connect*. Update progress is shown in *Messages* section.





Text *Port opened* appear after correctly opened port. Putting controller in update's mode can be done in two ways: remote from LU (with settings from LPCon – port, baudrate, transmission mode and adress) or by turning power on while button pressed . Message *boot* in the upper display signal the availability to update. LU will show message „Device found” with name and current version of firmware. Using button ... a valid file should be selected. If the file is correct, message *File opened* will show. *Send* button should be pressed. During firmware update the leds on the upper bargraph indicate process progress. If firmware update is successful device starts normal operation and message Done and update duration will show. Close LU and next press *Send* button to restore previously read parameters. Current firmware version can be checked when controller is power on.





Warning! Power loss during firmware update could result permanent controller damage!

16. ERROR SIGNALING

Character messages

Table 18

Error code (upper display)	Reason	Procedure
	Down overflow of the measuring range or shorting in the sensor circuit.	Check, if the type of chosen sensor is in compliance with the connected one; check, if input signal values are situated in the appropriate range – If yes, check if there is no break in the sensor circuit.
	Upper overflow of the measuring range or break in the sensor circuit.	Check, if the type of chosen sensor is in compliance with the connected one; check, if input signal values are situated in the appropriate range – If yes, check if there is no break in the sensor circuit.
	Incorrect controller configuration.	After selecting the valve opening on one output, the valve closing should be set on another output.
	Incorrect controller configuration.	After selecting the cooling type control on one output, the reverse control (heating) and the PID algorithm (ALG=PID) should be set on another output.
	Auto-tuning is ended with failure	Check the reason of the auto-tuning process interruption in the auto-tuning point.

	Input discalibrated	Turn off and turn on again the controller supply, when this not help, contact the nearest service shop.
	Continuous output discalibrated	Turn off and turn on again the controller supply, when this not help, contact the nearest service shop.
 	Error of readout verification from the non-volatile memory.	Turn off and turn on again the controller supply, when this not help, contact the nearest service shop. The controller exploitation in his state can cause its unforeseen behavior.

17. TECHNICAL DATA

MAIN INPUT

Input signals and measuring ranges

Table 19

Sensor type	Standard	Range		Symbol
Pt100	EN 60751+A2:1997	-200...850 °C	-328...1562 °F	$Pt\ 1$
Pt1000		-200...850 °C	-328...1562 °F	$Pt\ 10$
Fe-CuNi (J)	EN 60584- 1:1997	-100...1200 °C	-148...2192 °F	$t - J$
Cu-CuNi (T)		-100...400 °C	-148...752 °F	$t - t$
NiCr-NiAl (K)		-100...1372 °C	-148...2501,6 °F	$t - K$
PtRh10-Pt (S)		0...1767 °C	32...3212,6 °F	$t - S$
PtRh13-Pt (R)		0...1767 °C	32...3212,6 °F	$t - r$
PtRh30-PtRh6 (B)		0...1767 °C ¹⁾	32...3212,6 °F ¹⁾	$t - b$
NiCr-CuNi (E)		-100...1000 °C	-148...1832 °F	$t - E$
NiCrSi-NiSi (N)		-100...1300 °C	-148...2372 °F	$t - n$
Chromel – Kopel (L)		-100...800 °C	-148...1472 °F	$t - l$
Linear current (I)		GOST R 8.585- 2001	0...20 mA	0...20 mA
Linear current (I)	4...20 mA		4...20 mA	$I - 20$
Linear voltage (U)	0...5 V		0...5 V	$U - 5$
Linear voltage (U)	0...10 V		0...10 V	$U - 10$

¹⁾ The intrinsic error is related to measuring range 200...1767 °C (392...3212,6 °F)

Intrinsic error of the real value measurement

0.2%, for resistance thermometer inputs,

0.3%, for inputs for thermocouple sensors (0.5% – for B, R, S);

0.2% ± 1 digit, for linear inputs

Current flowing through the resistance

thermometer sensor 0.22 mA

Measurement time 0.2 s

Input resistance:

- for voltage input 150 kΩ

- for current input 50 Ω

Error detection in the measuring circuit:

- thermocouple, Pt100, Pt1000 overrun of measuring range

- 0...10 V over 11 V

- 0...5 V over 5.5 V

- 0...20 mA over 22 mA

- 4...20 mA over 1 mA
and over 22 mA

AUXILIARY INPUT

Measurement basic error

of real value 0.3% ± 1 digit

Measurement time 0.5 s

Input resistance 100 Ω

Setting range of controller parameters:

See table 1

Binary input

- shorting resistance
- opening out resistance

voltageless

$\leq 10 \text{ k}\Omega$

$\geq 100 \text{ k}\Omega$

Kinds of outputs 1 and 2:

- voltageless relay

NO contact, load capacity
2 A/230 V a.c.

- voltage transistor

0/5 V, maximum load capacity
40 mA

- continuous voltage

0...10 V at $R_{\text{load}} \geq 1 \text{ k}\Omega$

- continuous current

0...20 mA, 4...20 mA
at $R_{\text{load}} \leq 500 \Omega$

Kinds of outputs 3:

- voltageless relay

NO contact, load capacity
1 A/230 V a.c.

Kinds of outputs 4:

- voltageless relay

NC contact, load capacity
1 A/230 V a.c.

Way of output operation:

- reverse

for heating

- direct

for cooling

Error of analog outputs

0.2% of the range

Digital interface

- protocol RS-485
Modbus
- baud rate 4800, 9600, 19200, 38400,
57600 bit/s
- mode RTU – 8N2, 8E1, 8O1, 8N1
- address 1...247
- maximal response time 500 ms

Supply of object transducers24 V d.c. \pm 5 %, max.: 30 mA**Signaling:**

- turning outputs 1, 2, 3, 4 on
- mode of manual control
- auto-tuning process
- turning binary inputs 1, 2 on

Rated operating conditions:

- supply voltage 85...253 V a.c./d.c.
20...40 V a.c./d.c.
- frequency of supply voltage 40...440 Hz
- ambient temperature 0...23...50 °C
- storage temperature -20...+70 °C
- relative air humidity < 85 % (condensation
inadmissible)
- preheating time 30 min
- operating position any
- resistance of wires connecting
the resistance thermometer or
the thermocouple with the controller < 20 Ω / wire

Power input < 6 VA

Weight < 0.2 kg

Protection grade ensured by the casing acc. to EN 60529

- from the frontal plate IP65

- from the terminal side IP20

Additional errors in rated operating conditions caused by:

- compensation of thermocouple cold junction temperature changes $\leq 2\text{ }^{\circ}\text{C}$,
- ambient temperature change $\leq 100\%$ value of basic error /10 K.

Safety requirements acc. to EN 61010-1

- installation category III,
- pollution level 2,
- maximal phase-to-earth operating voltage:
 - for supply circuits, outputs 300 V
 - for input circuits 50 V
- altitude above sea < 2000 m

Electromagnetic compatibility

- noise immunity acc. to EN 61000-6-2
- noise emissions acc. to EN 61000-6-4

18. ORDERING CODE

The way of coding is given in the table 20.

Table 20

VC-88 -	X	X	X	X	X	X	X
Output 1:							
relay	1						
voltage 0/5 V	2						
continuous current 0/4 .. 20 mA	3						
continuous voltage 0 .. 10 V	4						
Output 2:							
relay ¹⁾	1						
voltage 0/5 V	2						
continuous current 0/4 .. 20 mA	3						
continuous voltage 0 .. 10 V	4						
Transducer supply:							
none							0
transducer supply 24 V d.c. /30mA							1
Supply:							
85 .. 253 V a.c./ d.c.						1	
20 .. 40 V a.c./ d.c.						2	
Version:							
standard							00
custom made ²⁾							XX
Language:							
English							E
other ²⁾							X
Acceptance tests:							
without extra quality requirements							0
with an extra quality inspection certificate							1
acc. to customer's request ²⁾							X

1) - Only, when a relay or a 0/5 V voltage is also selected on the output 1,

2) - Only after agreeing by the manufacturer

Ordering Example:

The code **VC-88 - 1 2 1 1 00 E 0** means:

VC-88 - controller of VC-88 type

1 - output 1: relay

2 - output 2: voltage 0/5 V

1 - transducer supply 24 V d.c./ 30 mA

1 - supply: 85 .. 253 V a.c./ d.c.

00 - standard version

E - English version of user's manual

0 - without extra quality requirements.

VC-88-09D



VALVE PRO

Valve Pro - division of Control Pro Inc.
Phone: (909) 464-9227

Email: sales.valvepro@hotmail.com